

LBB 10 UU OP ABC

Linear bushing

TYPE: Shaft guidance systems, Linear bushing, Standard, Open type for support rail, Type LBB..UU OP, sealed on both sides, inch

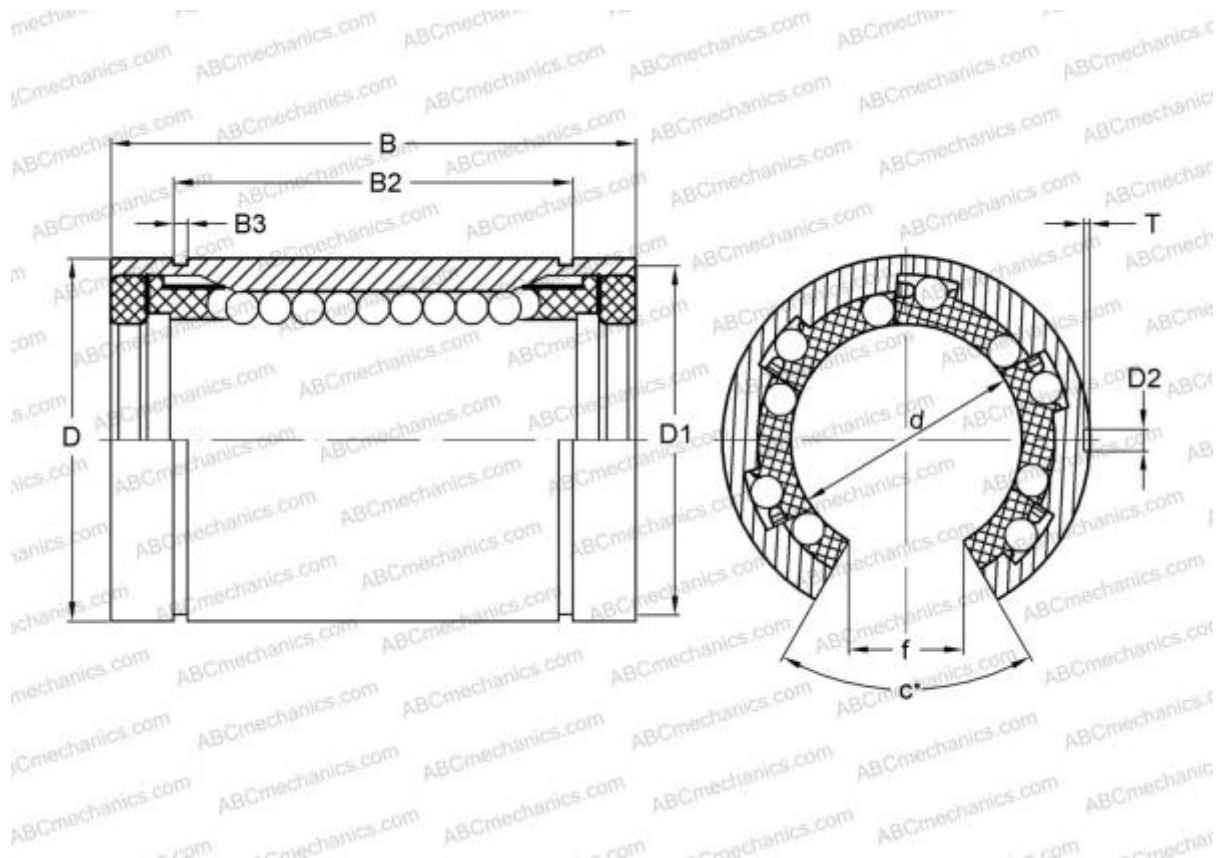

Technical specification

DIMENSIONS, MM

d	15,875
D	28,575
B	38,100
f	9,525
c	60

WEIGHT, KG 0,054

MANUFACTURER [ABC](#)

INTERCHANGE

IKO	LBB 10 UU OP
HEIM	OPN-625 PP