

## LBB 10 UU OP IKO

Linear bushing

TYPE: Shaft guidance systems, Linear bushing, Standard, Open type for support rail, Type LBB..UU OP, sealed on both sides, inch

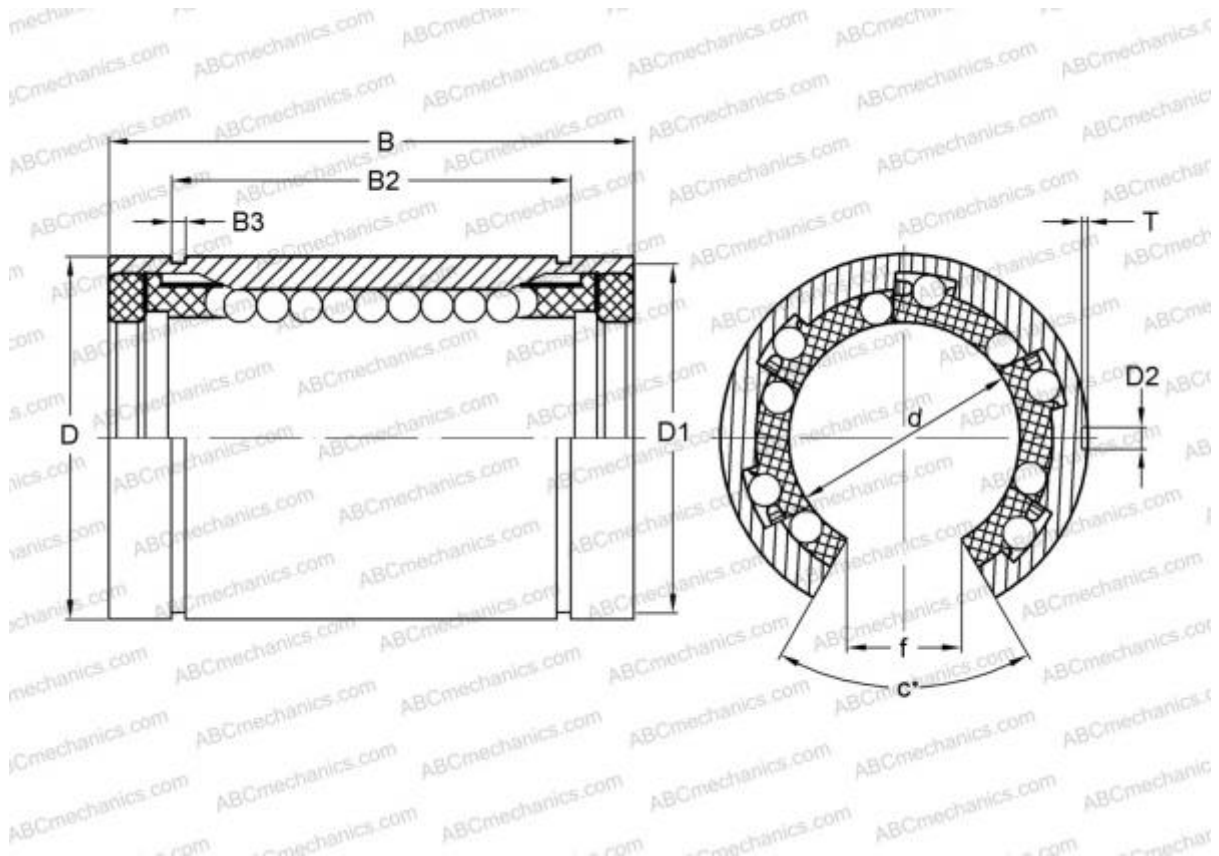

### Technical specification

#### DIMENSIONS, MM

d	15,875
D	28,575
B	38,100
f	9,525
c	60

**WEIGHT, KG** 0,054

**MANUFACTURER** [IKO](#)

#### INTERCHANGE

ABC	<a href="#">LBB 10 UU OP</a>
HEIM	<a href="#">OPN-625 PP</a>

#### CALCULATION DATA

Basic dynamic load rating min	0,424 kN
Basic dynamic load rating max	0,488 kN

#### CALCULATION DATA

Basic static load rating min	0,766 kN
Basic static load rating max	1,080 kN