

LBB 12 UU OP ABC

Linear bushing

TYPE: Shaft guidance systems, Linear bushing, Standard, Open type for support rail, Type LBB..UU OP, sealed on both sides, inch

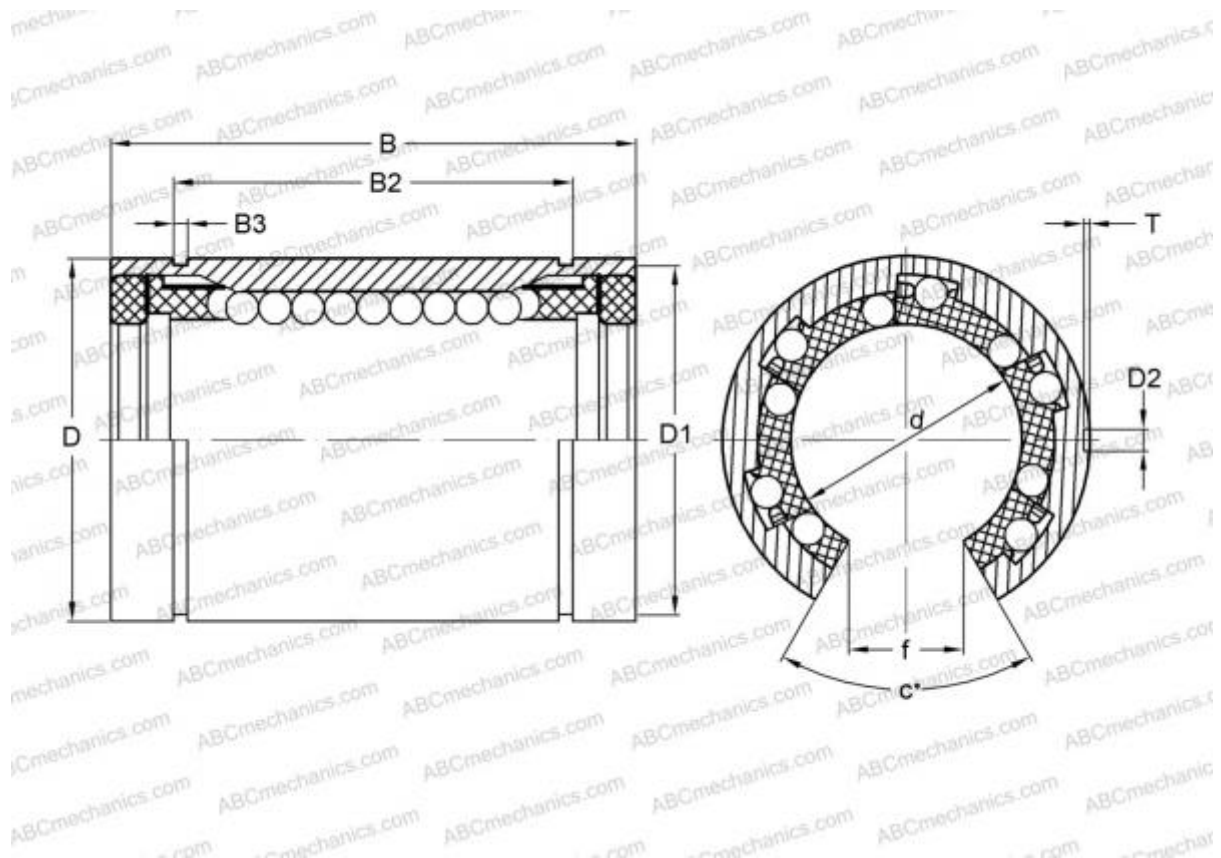

Technical specification

DIMENSIONS, MM

d	19,050
D	31,750
B	41,275
f	11,112
c	60

WEIGHT, KG 0,069

MANUFACTURER [ABC](#)

INTERCHANGE

IKO	LBB 12 UU OP
HEIM	OPN-750 PP