

LBB 12 UU OP IKO

Linear bushing

TYPE: Shaft guidance systems, Linear bushing, Standard, Open type for support rail, Type LBB..UU OP, sealed on both sides, inch

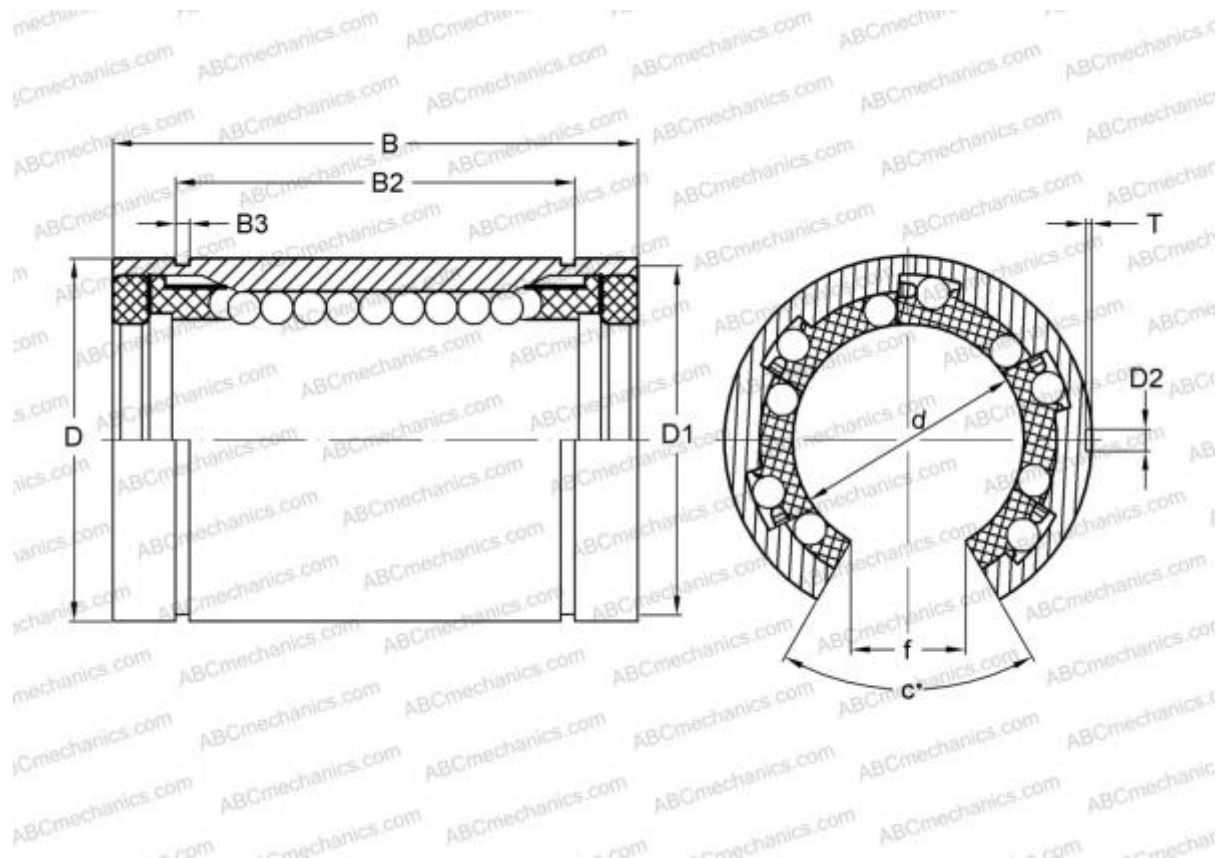

Technical specification

DIMENSIONS, MM

d	19,050
D	31,750
B	41,275
f	11,112
c	60

WEIGHT, KG 0,069

MANUFACTURER [IKO](#)

INTERCHANGE

ABC	LBB 12 UU OP
HEIM	OPN-750 PP

CALCULATION DATA

Basic dynamic load rating min	0,608 kN
Basic dynamic load rating max	0,724 kN

CALCULATION DATA

Basic static load rating min	1,150 kN
Basic static load rating max	1,680 kN