

## LBB 20 UU OP IKO

Linear bushing

TYPE: Shaft guidance systems, Linear bushing, Standard, Open type for support rail, Type LBB..UU OP, sealed on both sides, inch

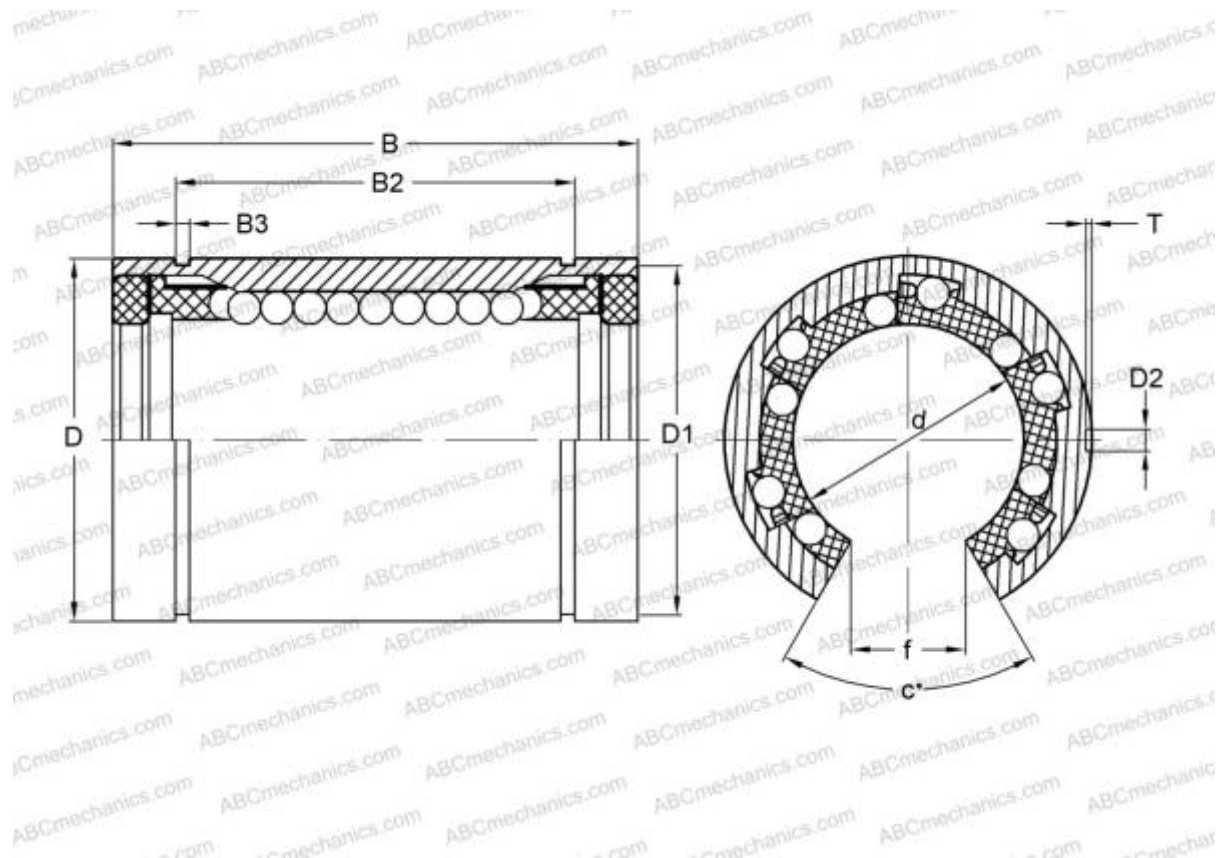

### Technical specification

#### DIMENSIONS, MM

d	31,750
D	50,800
B	66,675
f	15,875
c	50

**WEIGHT, KG** 0,290

**MANUFACTURER** [IKO](#)

#### INTERCHANGE

ABC	<a href="#">LBB 20 UU OP</a>
HEIM	<a href="#">OPN-1250 PP</a>

#### CALCULATION DATA

Basic dynamic load rating min	1,920 kN
Basic dynamic load rating max	2,030 kN

#### CALCULATION DATA

Basic static load rating min	3,570 kN
Basic static load rating max	4,570 kN