

## LBB 24 UU OP ABC

Linear bushing

TYPE: Shaft guidance systems, Linear bushing, Standard, Open type for support rail, Type LBB..UU OP, sealed on both sides, inch

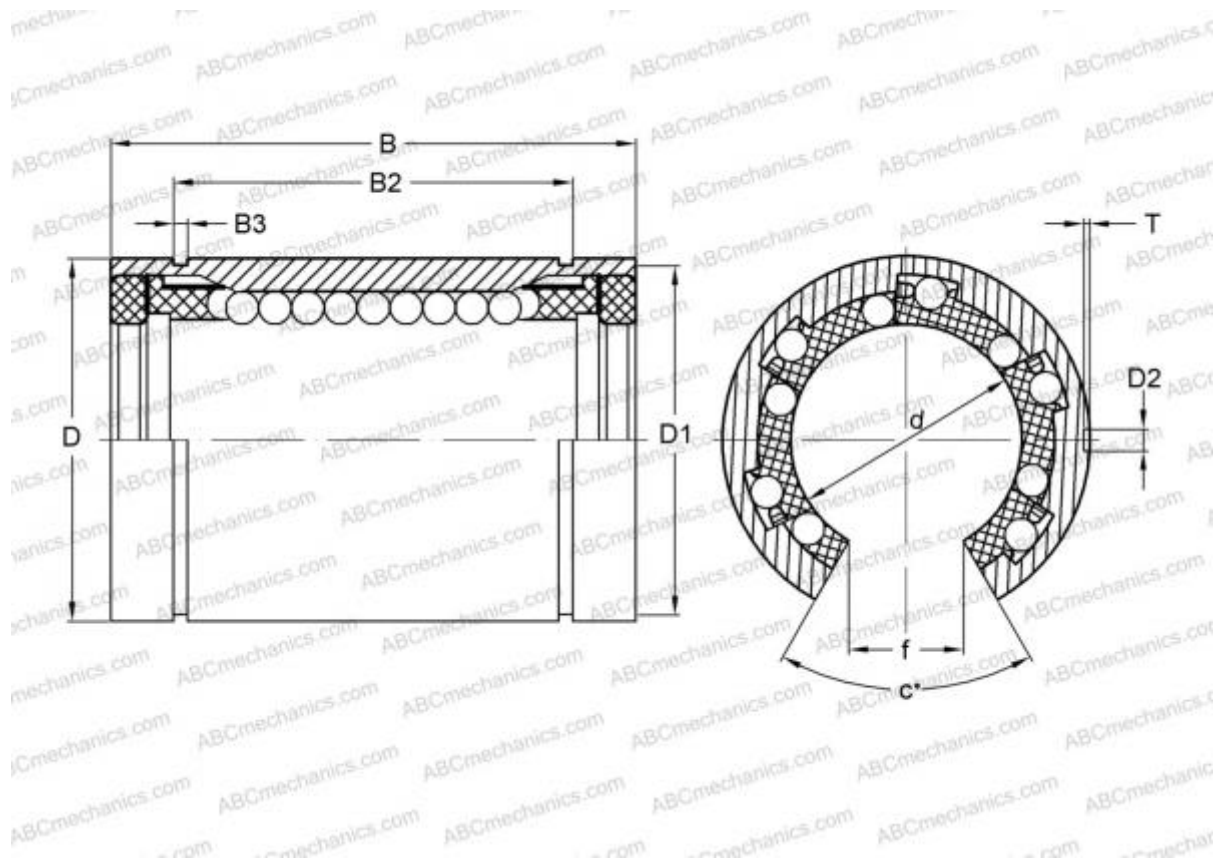

### Technical specification

#### DIMENSIONS, MM

d	38,100
D	60,325
B	76,200
f	19,050
c	50

**WEIGHT, KG** 0,475

**MANUFACTURER** [ABC](#)

#### INTERCHANGE

IKO	<a href="#">LBB 24 UU OP</a>
HEIM	<a href="#">OPN-1500 PP</a>