

LBD 6 IKO

Linear bushing

TYPE: Shaft guidance systems, Linear bushing, Standard, Close type, Type LBD

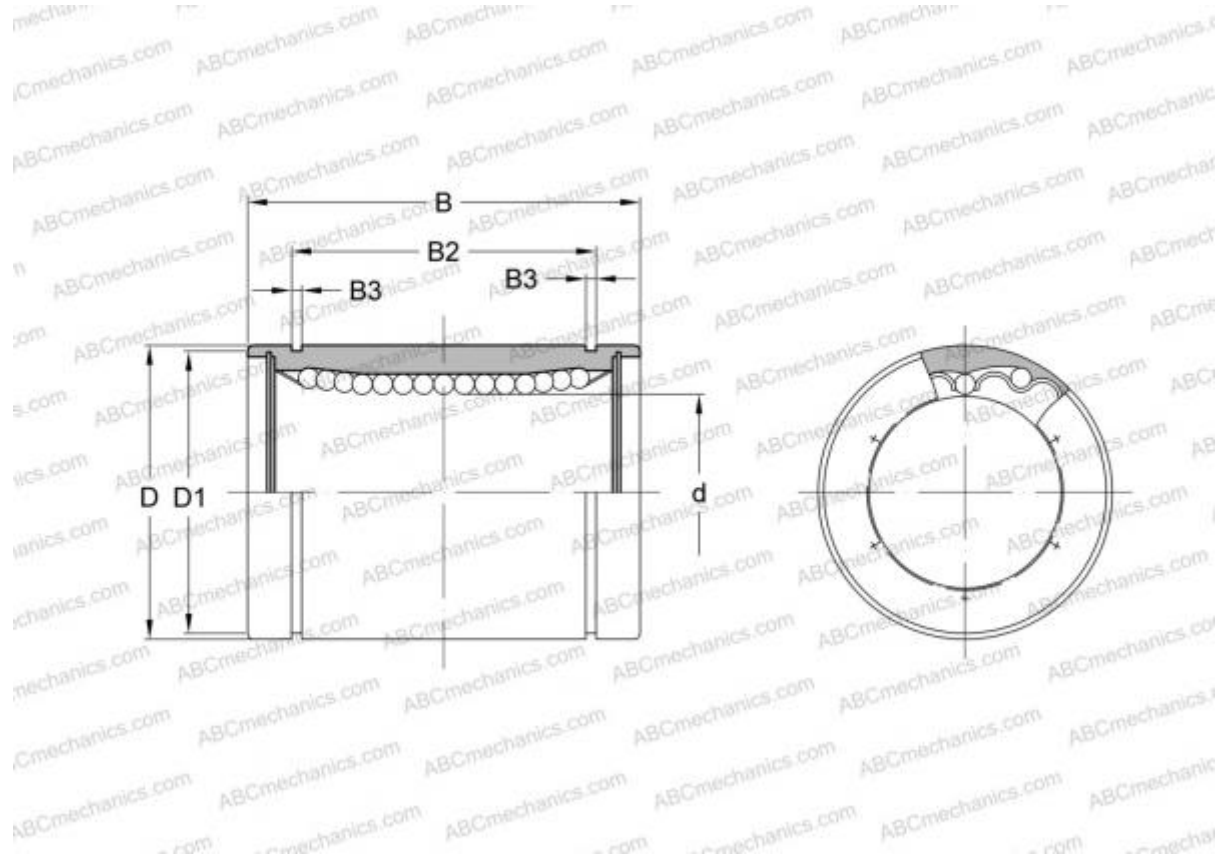

Technical specification

DIMENSIONS, MM

d	6,000
D	12,000
B	19,000

WEIGHT 0,005

MANUFACTURER [IKO](#)

INTERCHANGE

ABC [LBD 6](#)

CALCULATION DATA

Basic dynamic load rating min	0,078 kN
Basic dynamic load rating max	0,063 kN
Basic static load rating min	0,155 kN
Basic static load rating max	0,155 kN