

LBD 8 ABC

Linear bushing

TYPE: Shaft guidance systems, Linear bushing, Standard, Close type, Type LBD

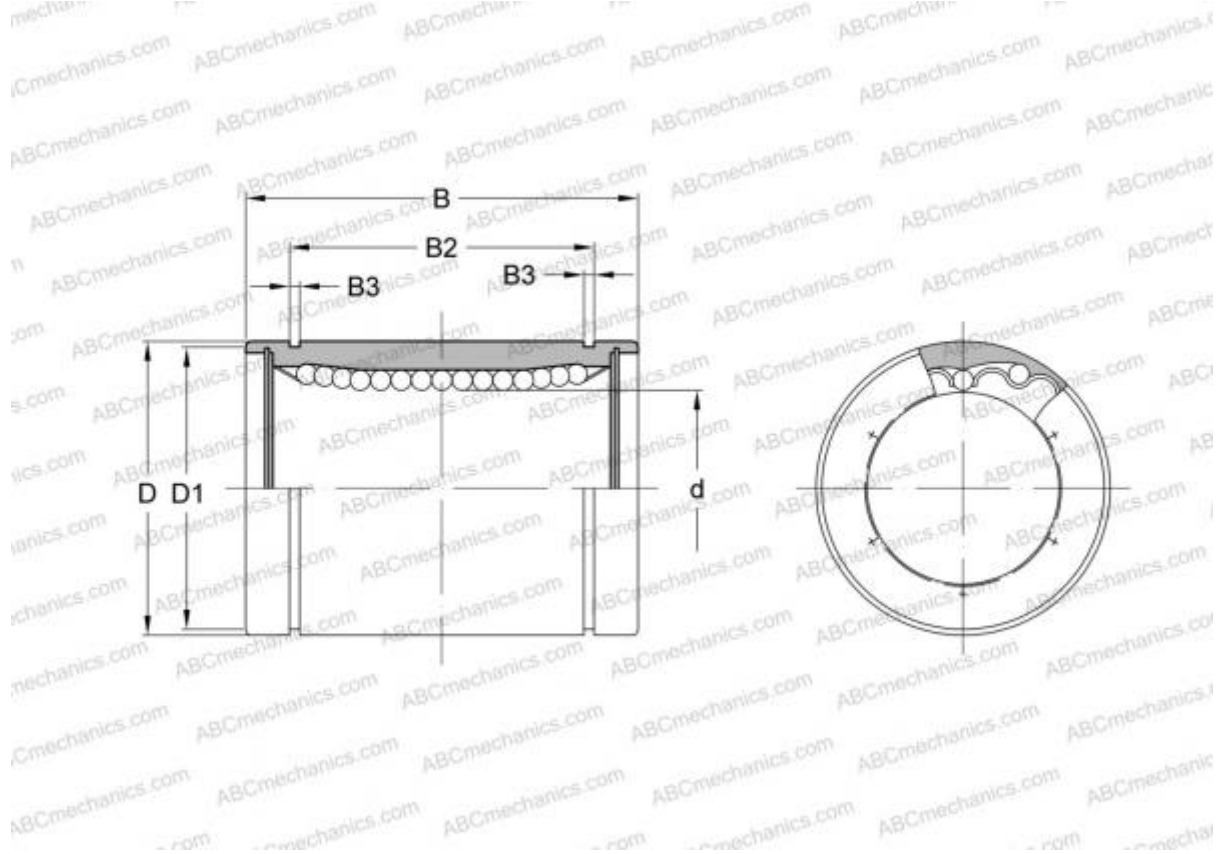

Technical specification

DIMENSIONS, MM

d	8,000
D	15,000
B	24,000

WEIGHT 0,012

MANUFACTURER [ABC](#)

INTERCHANGE

IKO [LBD 8](#)