

## LBD 16 ABC

Linear bushing

TYPE: Shaft guidance systems, Linear bushing, Standard, Close type, Type LBD

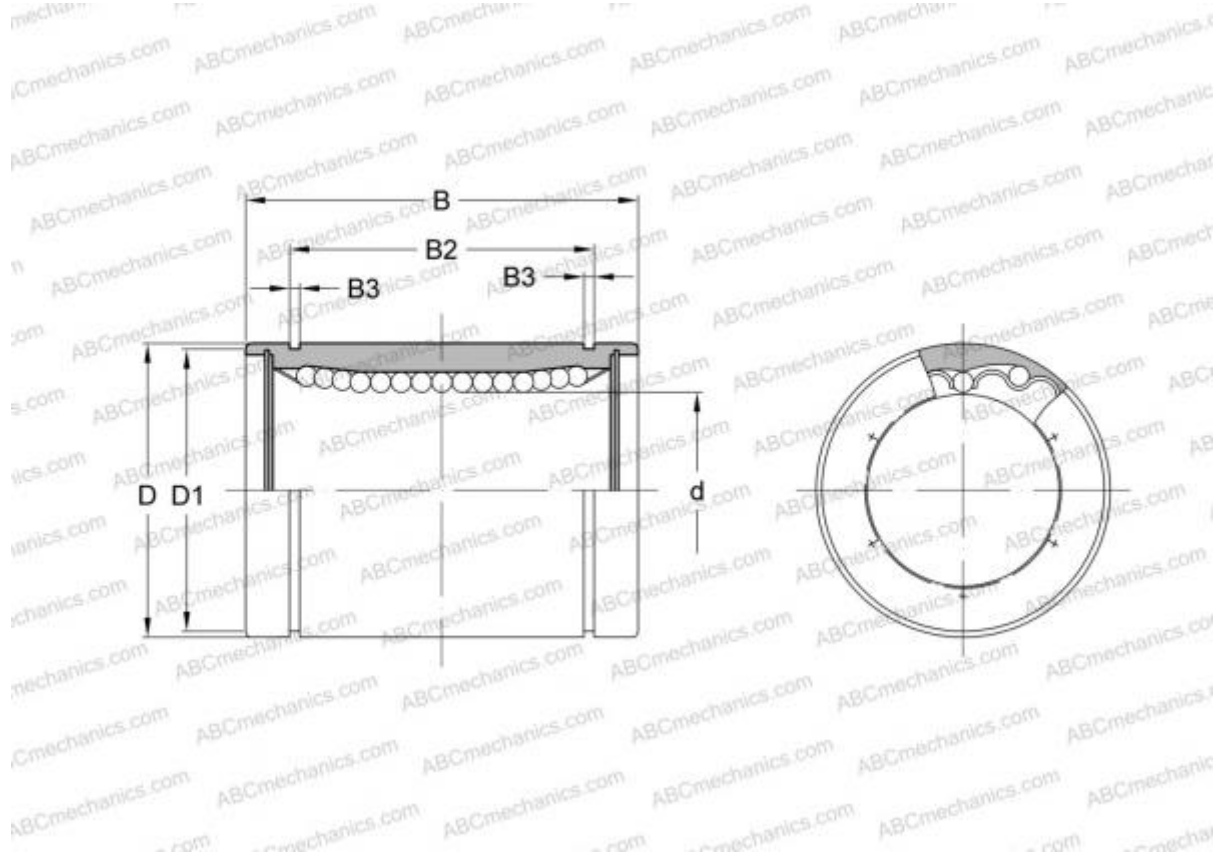

### Technical specification

#### DIMENSIONS, MM

d	16,000
D	28,000
B	37,000

**WEIGHT, KG** 0,058

**MANUFACTURER** [ABC](#)

#### INTERCHANGE

IKO [LBD 16](#)