

LBD 16 IKO

Linear bushing

TYPE: Shaft guidance systems, Linear bushing, Standard, Close type, Type LBD

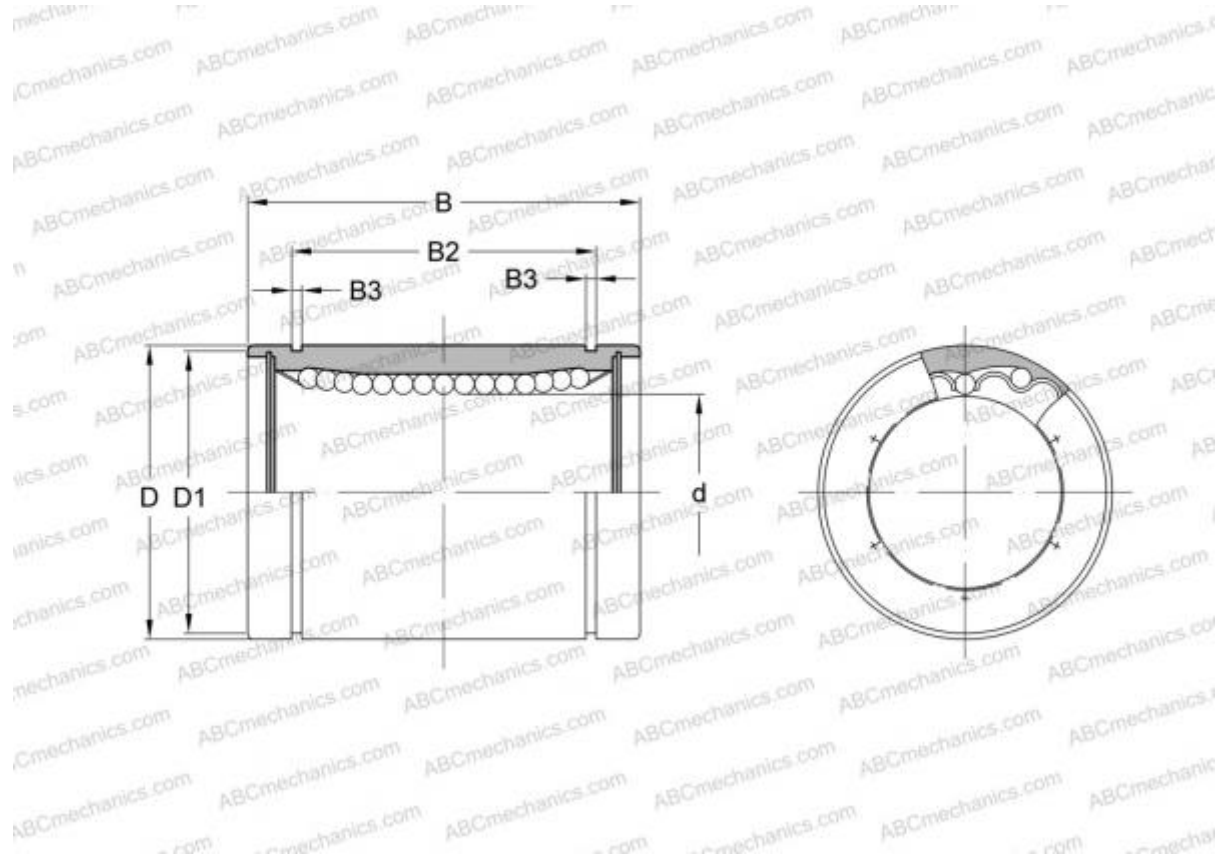

Technical specification

DIMENSIONS, MM

d	16,000
D	28,000
B	37,000

WEIGHT, KG 0,058

MANUFACTURER [IKO](#)

INTERCHANGE

ABC	LBD 16
-----	------------------------

CALCULATION DATA

Basic dynamic load rating min	0,426 kN
Basic dynamic load rating max	0,489 kN
Basic static load rating min	0,766 kN
Basic static load rating max	1,080 kN