

LBD 16 AJ ABC

Linear bushing

TYPE: Shaft guidance systems, Linear bushing, Standard, Adjustable type, Type LBD..AJ

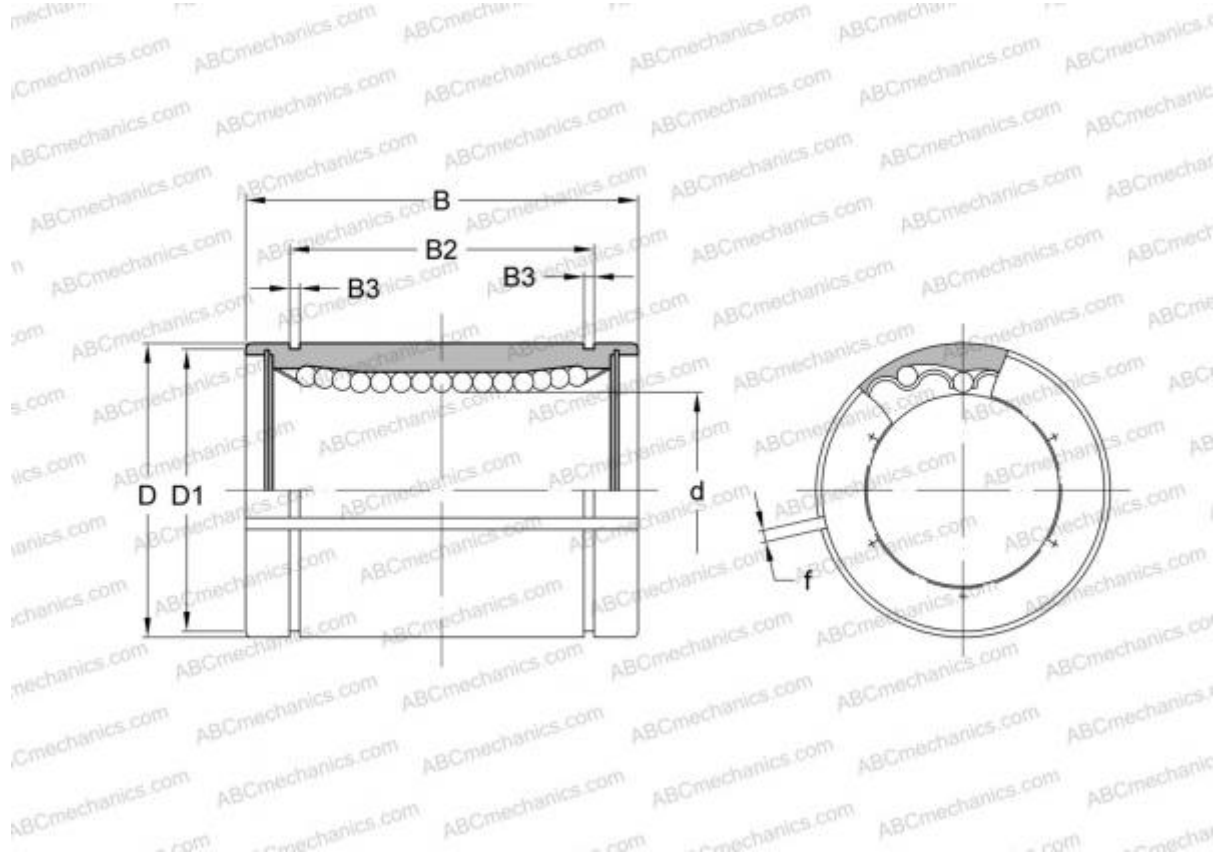

Technical specification

DIMENSIONS, MM

d	16,000
D	28,000
B	37,000
f	1,500

WEIGHT, KG 0,057

MANUFACTURER [ABC](#)

INTERCHANGE

IKO [LBD 16 AJ](#)