

LBD 10 OP ABC

Linear bushing

TYPE: Shaft guidance systems, Linear bushing, Standard, Open type for support rail, Type LBD..OP

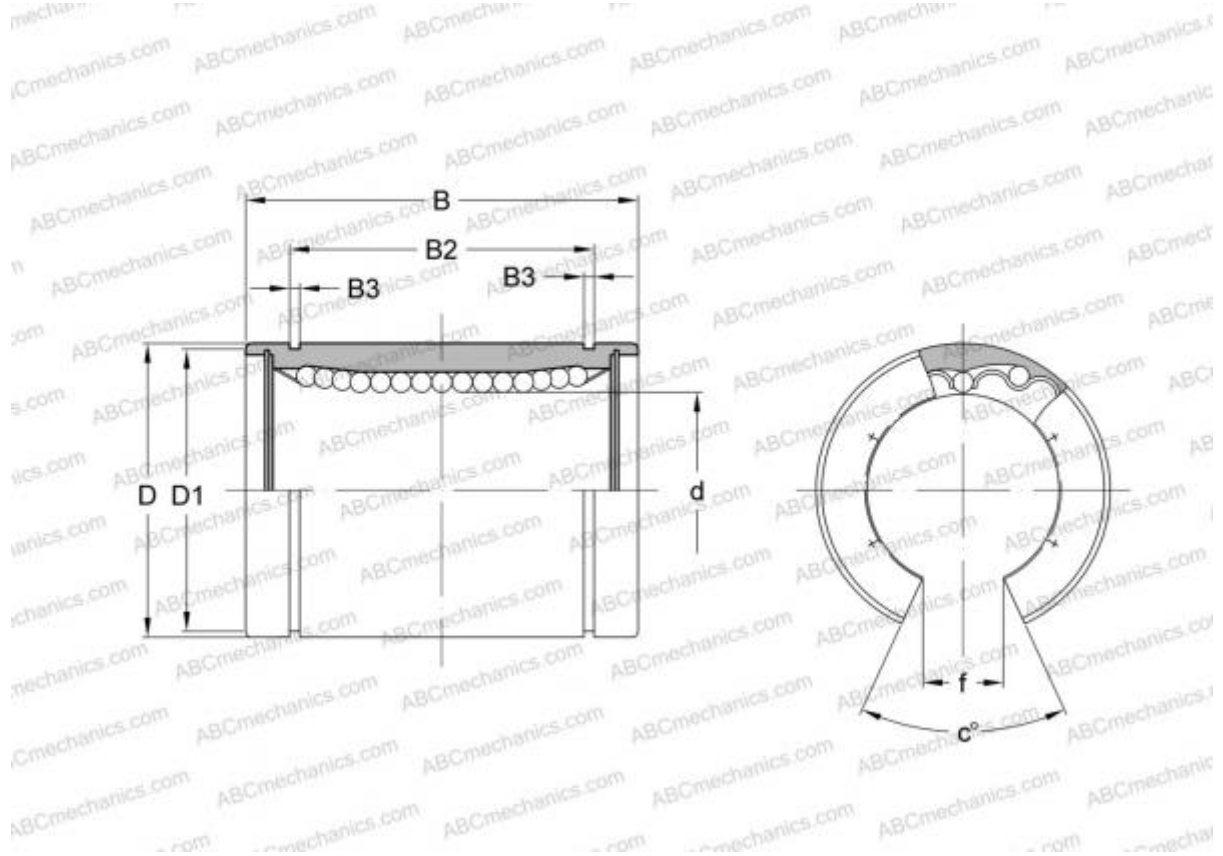

Technical specification

DIMENSIONS, MM

d	10,000
D	19,000
B	29,000
f	7,000
c	80

WEIGHT, KG 0,021

MANUFACTURER [ABC](#)

INTERCHANGE

IKO [LBD 10 OP](#)