

## LBD 13 OP IKO

Linear bushing

TYPE: Shaft guidance systems, Linear bushing, Standard, Open type for support rail, Type LBD..OP

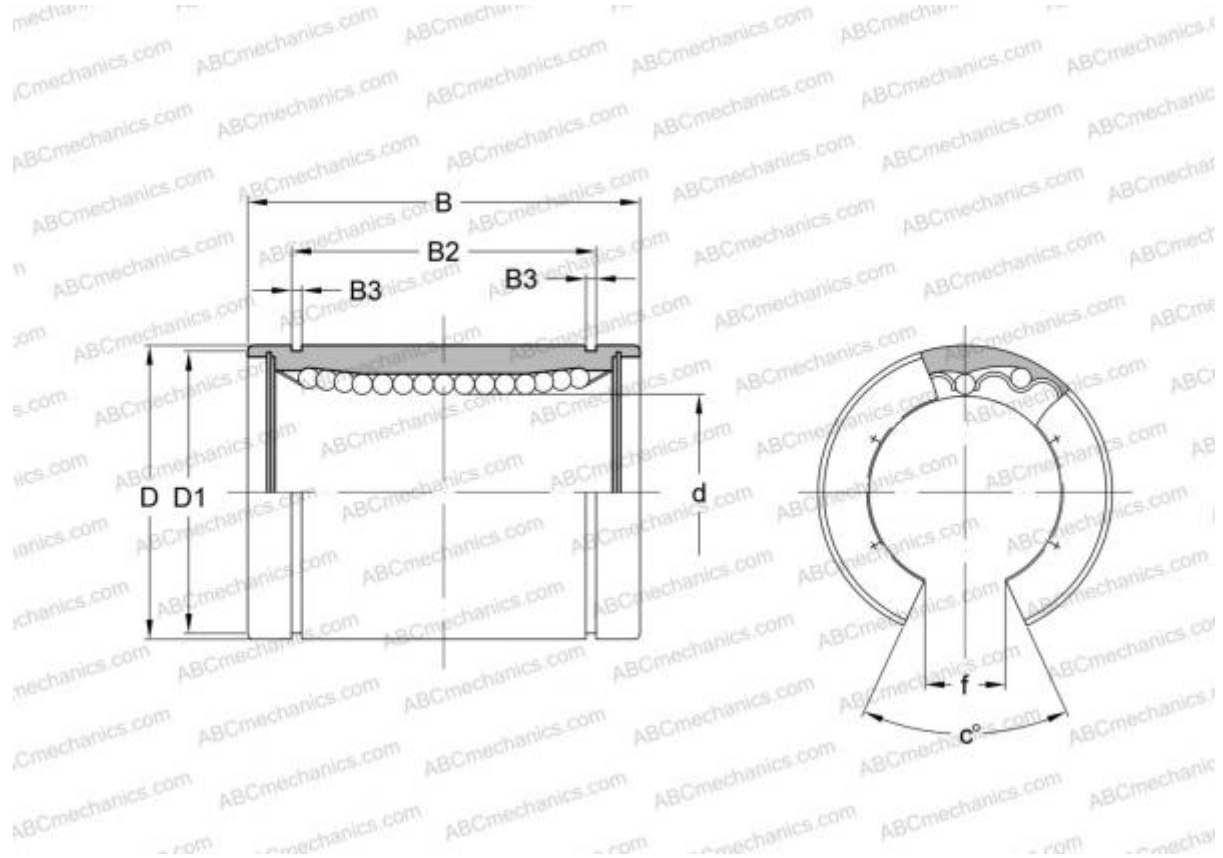

### Technical specification

#### DIMENSIONS, MM

d	13,000
D	23,000
B	32,000
f	9,000
c	80

**WEIGHT, KG** 0,033

**MANUFACTURER** [IKO](#)

#### INTERCHANGE

ABC [LBD 13 OP](#)

#### CALCULATION DATA

Basic dynamic load rating min	0,292 kN
Basic dynamic load rating max	0,336 kN
Basic static load rating min	0,578 kN

#### CALCULATION DATA

Basic static load rating max	0,818 kN
------------------------------	----------