

## LBD 25 OP ABC

Linear bushing

TYPE: Shaft guidance systems, Linear bushing, Standard, Open type for support rail, Type LBD..OP

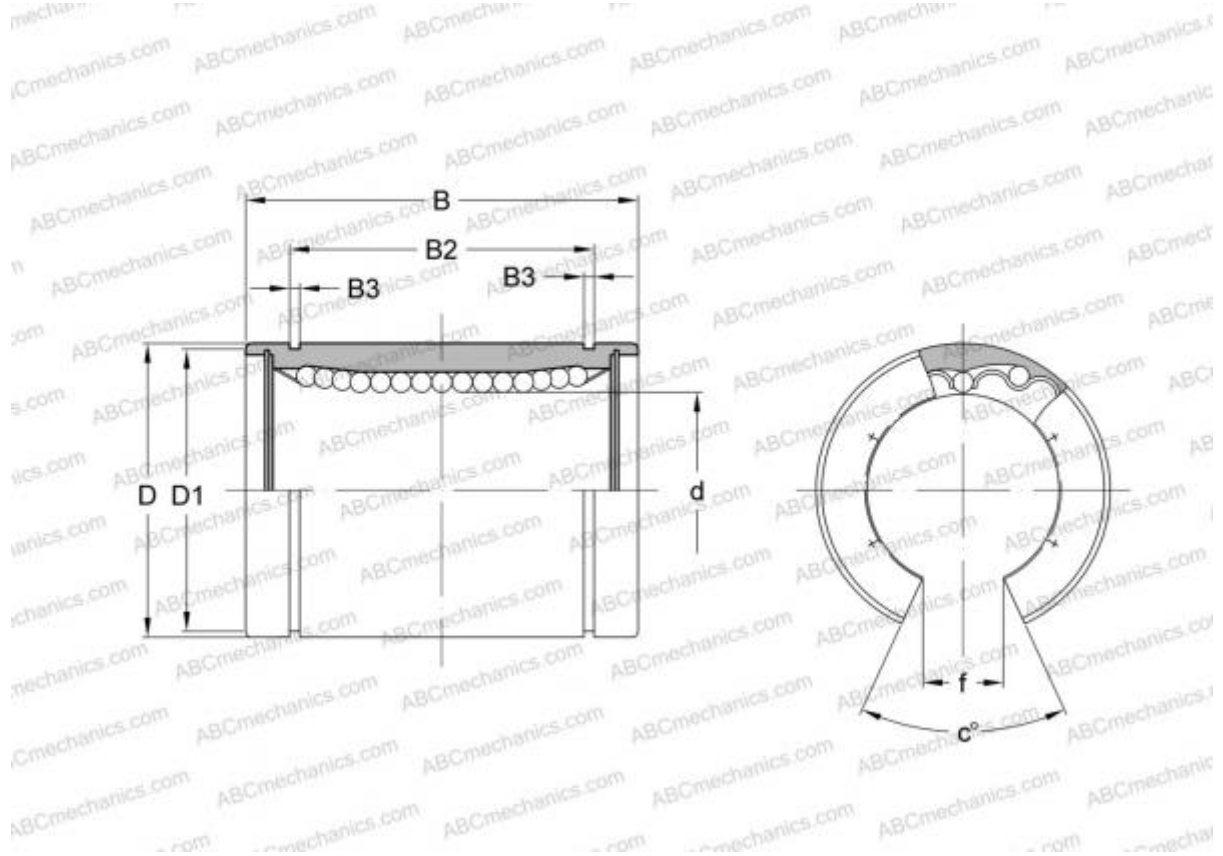

### Technical specification

#### DIMENSIONS, MM

d	25,000
D	40,000
B	59,000
f	12,000
c	50

**WEIGHT, KG** 0,142

**MANUFACTURER** [ABC](#)

#### INTERCHANGE

IKO [LBD 25 OP](#)