

LBD 20 UU ABC

Linear bushing

TYPE: Shaft guidance systems, Linear bushing, Standard, Close type, Type LBD..UU, sealed on both sides

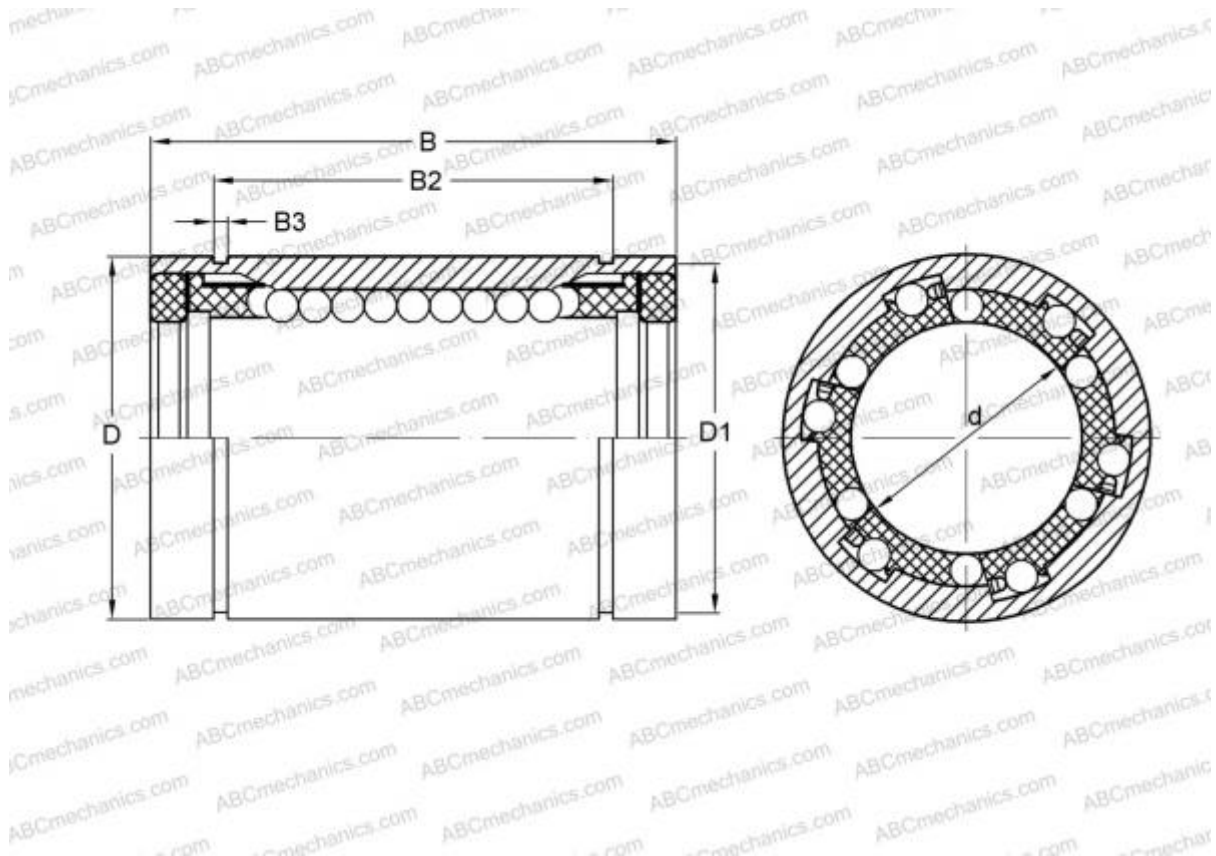

Technical specification

DIMENSIONS, MM

d	20,000
D	32,000
B	42,000

WEIGHT, KG 0,081

MANUFACTURER [ABC](#)

INTERCHANGE

IKO	LBD 20 UU
-----	---------------------------