

## LBD 20 UU IKO

Linear bushing

TYPE: Shaft guidance systems, Linear bushing, Standard, Close type, Type LBD..UU, sealed on both sides

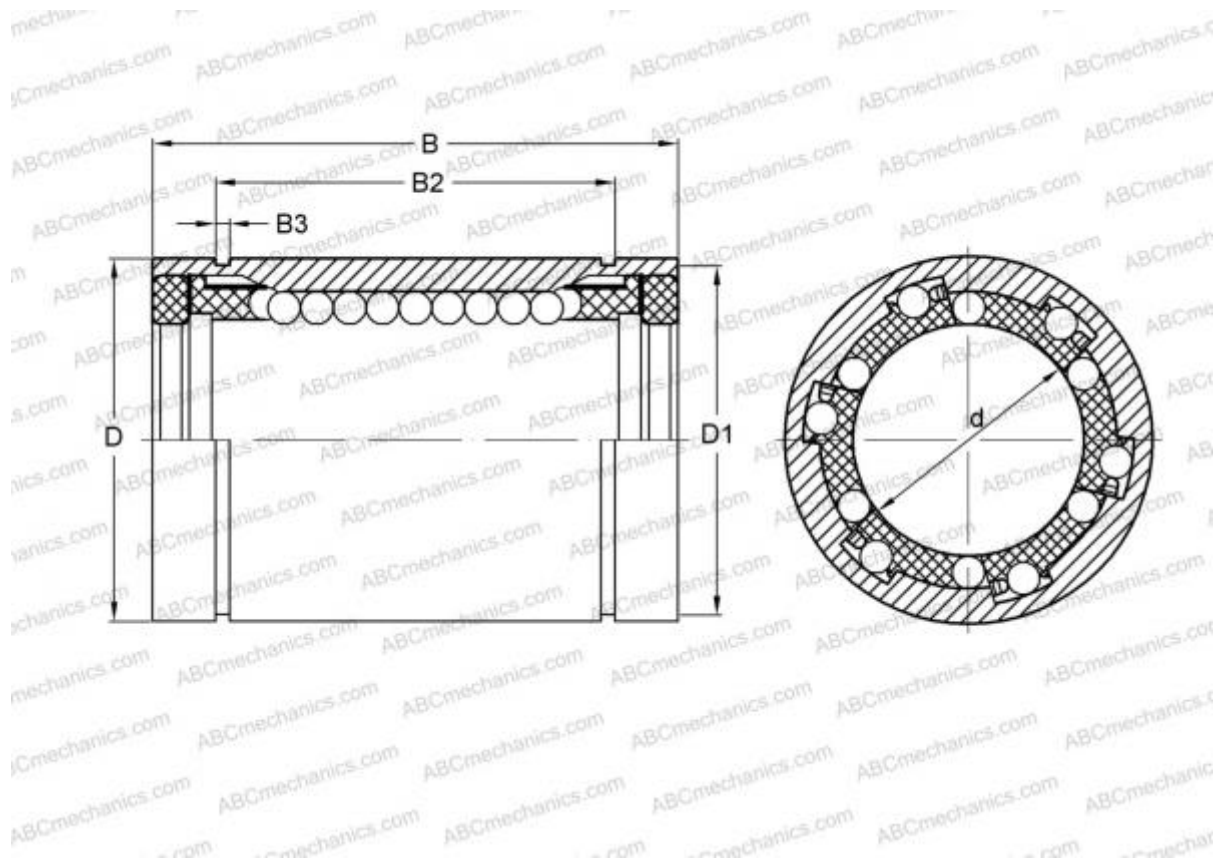

### Technical specification

#### DIMENSIONS, MM

d	20,000
D	32,000
B	42,000

**WEIGHT, KG** 0,081

**MANUFACTURER** [IKO](#)

#### INTERCHANGE

ABC	<a href="#">LBD 20 UU</a>
-----	---------------------------

#### CALCULATION DATA

Basic dynamic load rating min	0,617 kN
Basic dynamic load rating max	0,734 kN
Basic static load rating min	1,150 kN
Basic static load rating max	1,680 kN