

LBD 25 UU ABC

Linear bushing

TYPE: Shaft guidance systems, Linear bushing, Standard, Close type, Type LBD..UU, sealed on both sides

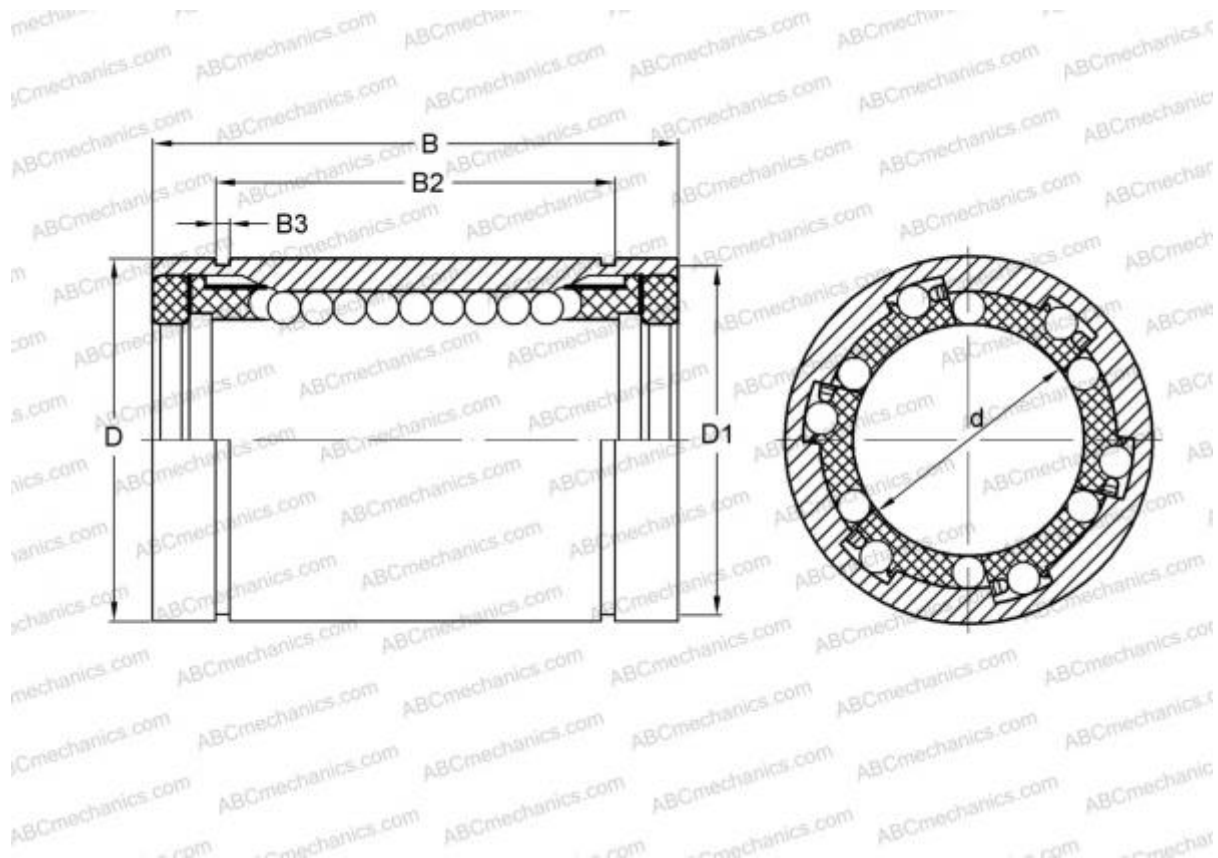

Technical specification

DIMENSIONS, MM

d	25,000
D	40,000
B	59,000

WEIGHT, KG 0,161

MANUFACTURER [ABC](#)

INTERCHANGE

IKO	LBD 25 UU
-----	---------------------------