

## LBD 25 UU IKO

Linear bushing

TYPE: Shaft guidance systems, Linear bushing, Standard, Close type, Type LBD..UU, sealed on both sides

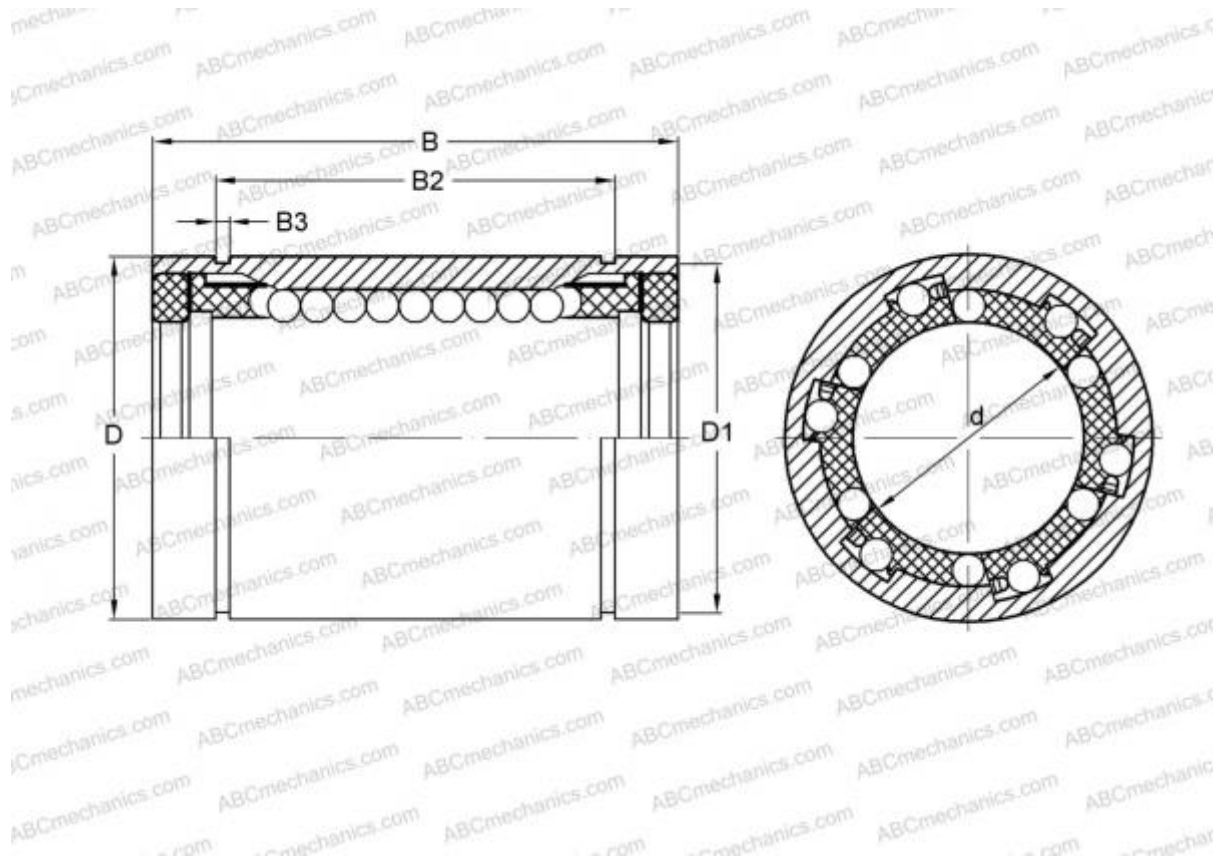

### Technical specification

#### DIMENSIONS, MM

d	25,000
D	40,000
B	59,000

**WEIGHT, KG** 0,161

**MANUFACTURER** [IKO](#)

#### INTERCHANGE

ABC	<a href="#">LBD 25 UU</a>
-----	---------------------------

#### CALCULATION DATA

Basic dynamic load rating min	1,070 kN
Basic dynamic load rating max	1,270 kN
Basic static load rating min	2,020 kN
Basic static load rating max	2,960 kN