

LBD 16 UU AJ ABC

Linear bushing

TYPE: Shaft guidance systems, Linear bushing, Standard, Adjustable type, Type LBD..UU AJ, sealed on both sides

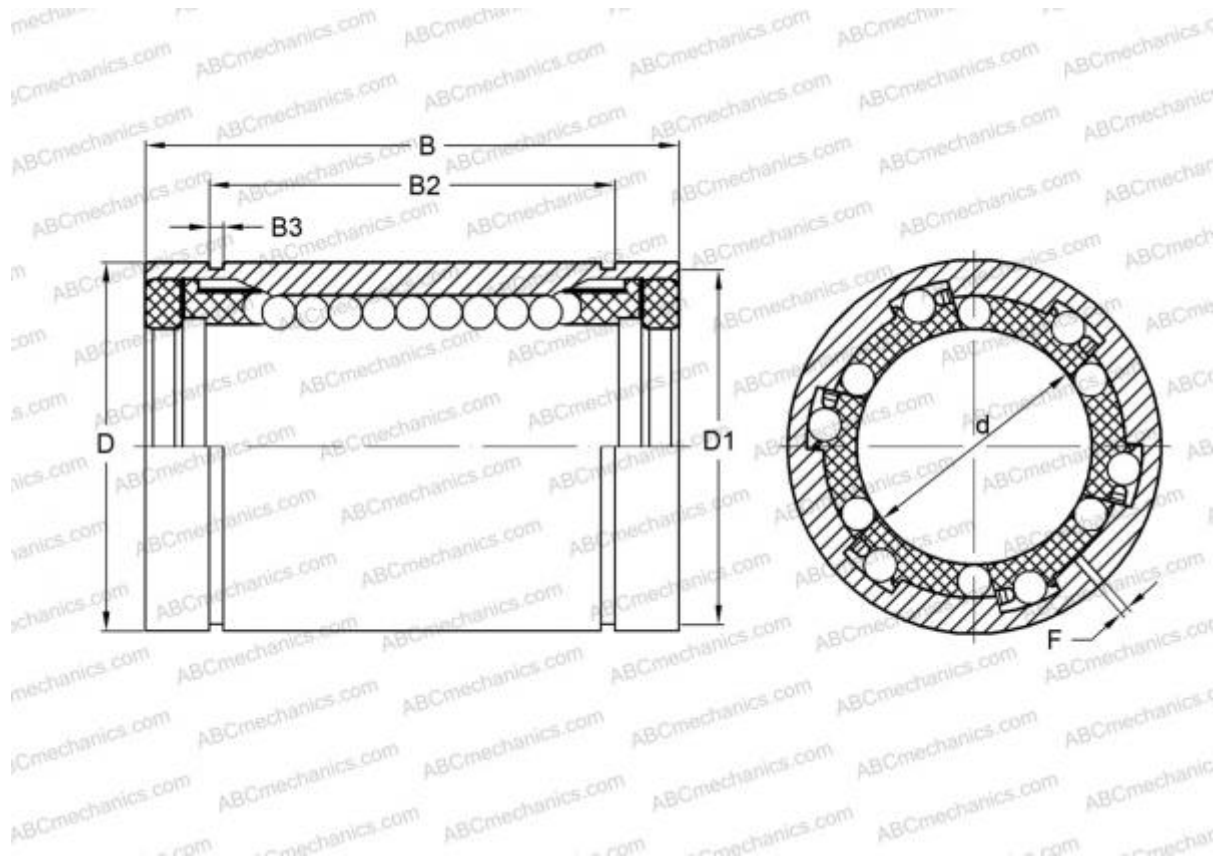

Technical specification

DIMENSIONS, MM

d	16,000
D	28,000
B	37,000
f	1,500

WEIGHT, KG 0,057

MANUFACTURER [ABC](#)

INTERCHANGE

IKO	LBD 16 UU AJ
-----	------------------------------