

LBD 13 UU OP ABC

Linear bushing

TYPE: Shaft guidance systems, Linear bushing, Standard, Open type for support rail, Type LBD..UU OP, sealed on both sides

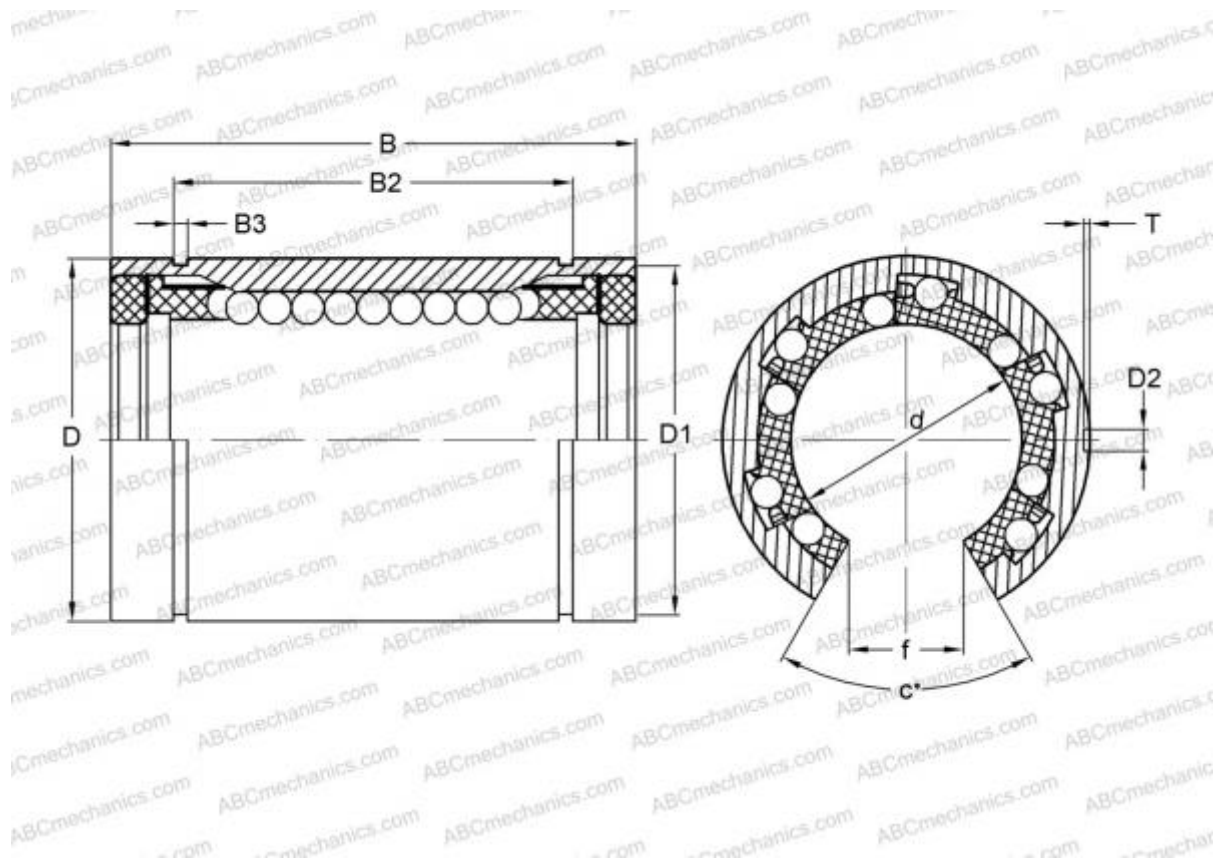

Technical specification

DIMENSIONS, MM

d	13,000
D	23,000
B	32,000
f	9,000
c	80

WEIGHT, KG 0,034

MANUFACTURER [ABC](#)

INTERCHANGE

IKO [LBD 13 UU OP](#)