

LBD 16 UU OP ABC

Linear bushing

TYPE: Shaft guidance systems, Linear bushing, Standard, Open type for support rail, Type LBD..UU OP, sealed on both sides

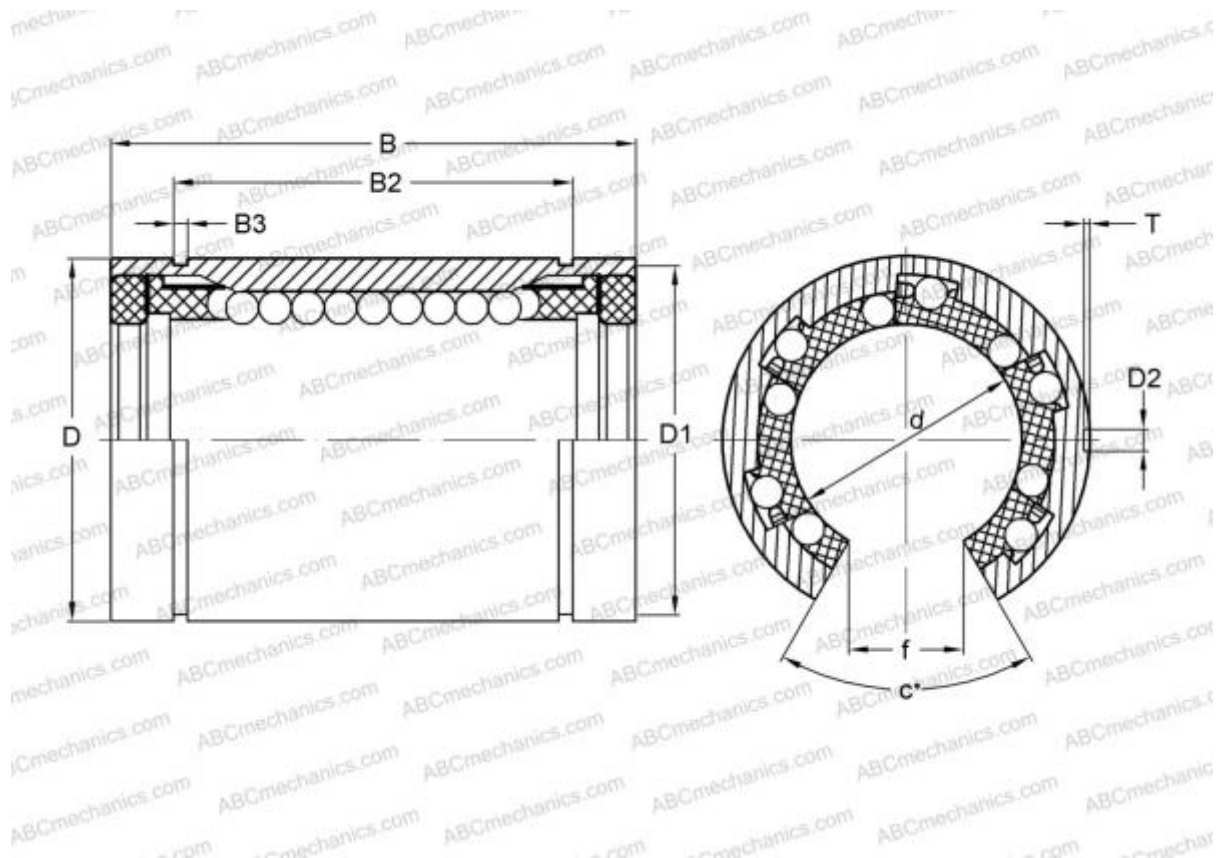

Technical specification

DIMENSIONS, MM

| | |
|---|--------|
| d | 16,000 |
| D | 28,000 |
| B | 37,000 |
| f | 11,000 |
| c | 80 |

WEIGHT, KG 0,048

MANUFACTURER [ABC](#)

INTERCHANGE

IKO [LBD 16 UU OP](#)