

LBD 16 UU OP IKO

Linear bushing

TYPE: Shaft guidance systems, Linear bushing, Standard, Open type for support rail, Type LBD..UU OP, sealed on both sides

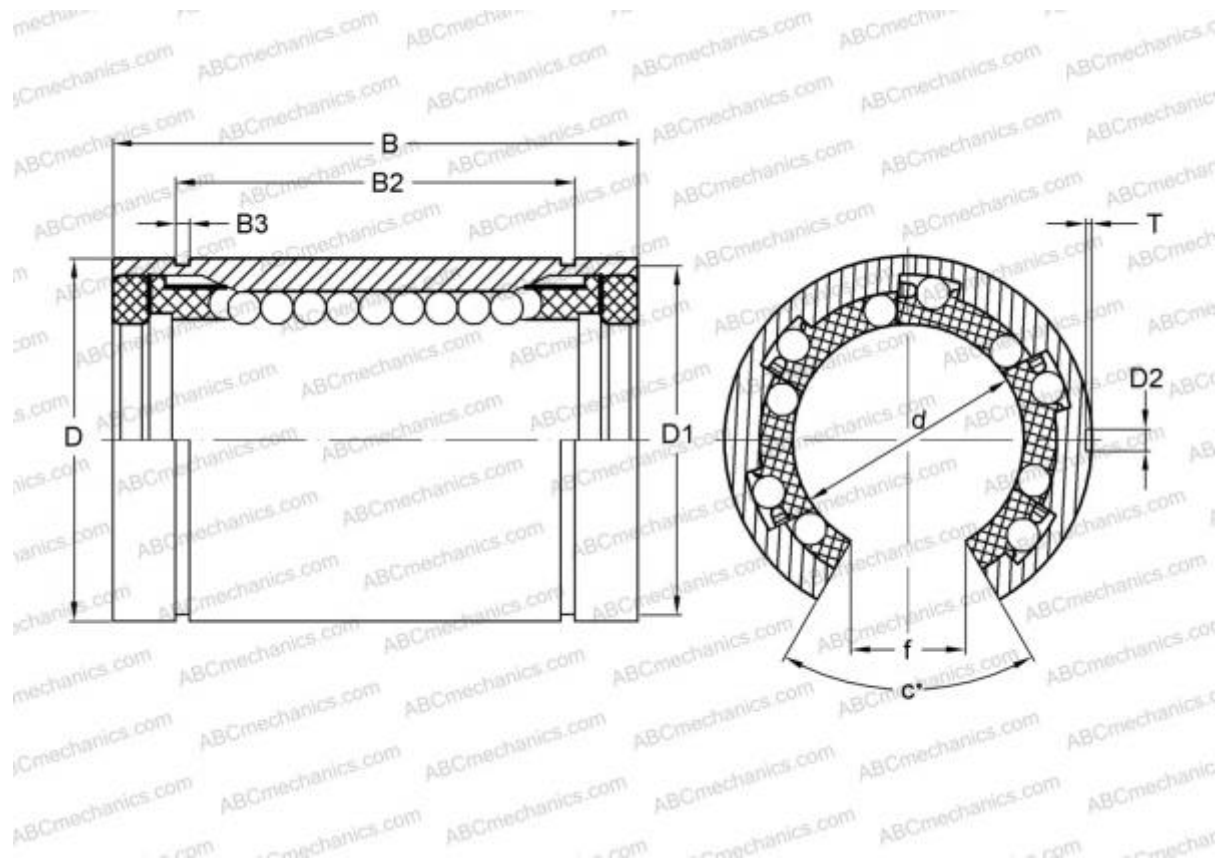

Technical specification

DIMENSIONS, MM

d	16,000
D	28,000
B	37,000
f	11,000
c	80

WEIGHT, KG 0,048

MANUFACTURER [IKO](#)

INTERCHANGE

ABC [LBD 16 UU OP](#)

CALCULATION DATA

Basic static load rating max 1,080 kN

CALCULATION DATA

Basic dynamic load rating min	0,426 kN
Basic dynamic load rating max	0,489 kN
Basic static load rating min	0,766 kN