

LBD 25 UU OP IKO

Linear bushing

TYPE: Shaft guidance systems, Linear bushing, Standard, Open type for support rail, Type LBD..UU OP, sealed on both sides

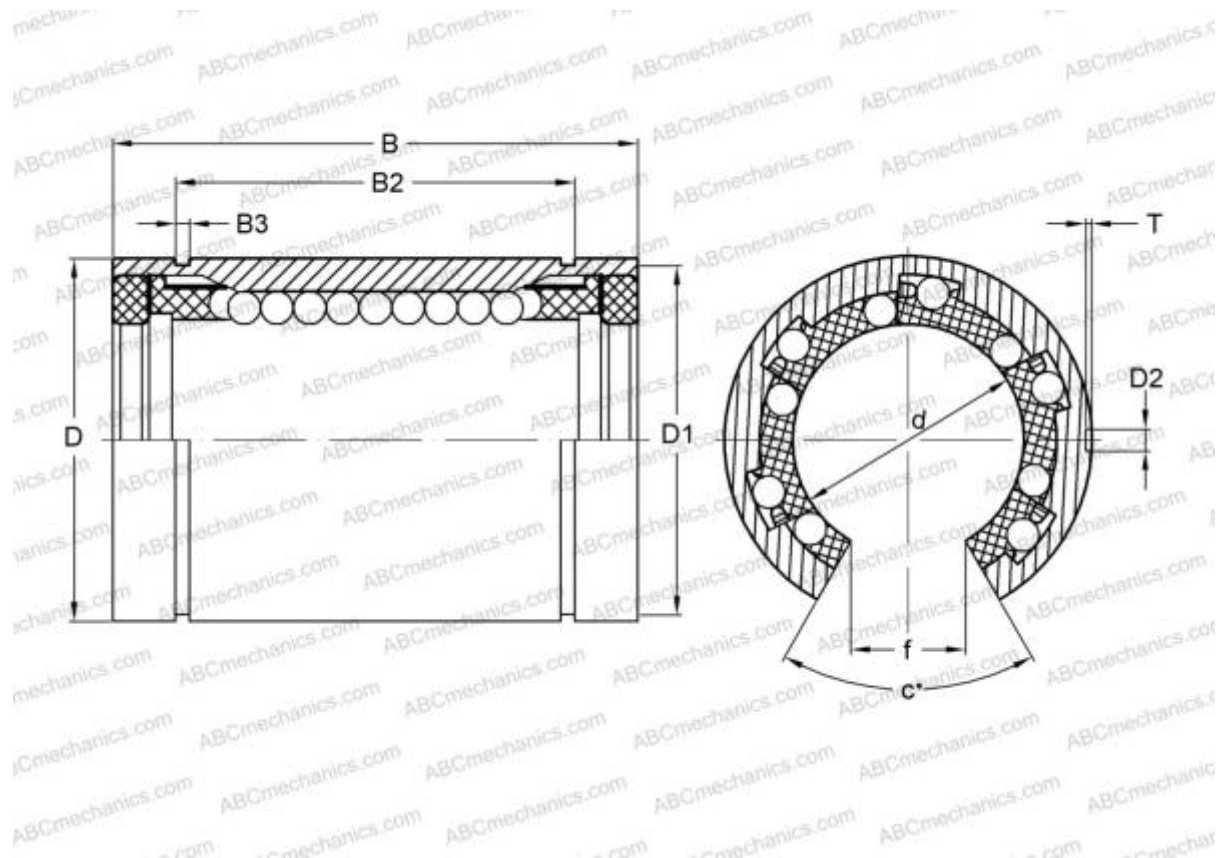

Technical specification

DIMENSIONS, MM

d	25,000
D	40,000
B	59,000
f	12,000
c	50

WEIGHT, KG 0,143

MANUFACTURER [IKO](#)

INTERCHANGE

ABC [LBD 25 UU OP](#)

CALCULATION DATA

Basic static load rating max 2,960 kN

CALCULATION DATA

Basic dynamic load rating min	1,070 kN
Basic dynamic load rating max	1,270 kN
Basic static load rating min	2,020 kN