

LM 101929 N IKO

Linear bushing

TYPE: Shaft guidance systems, Linear bushing, Standard, Close type, Type LM..(N) (IKO)

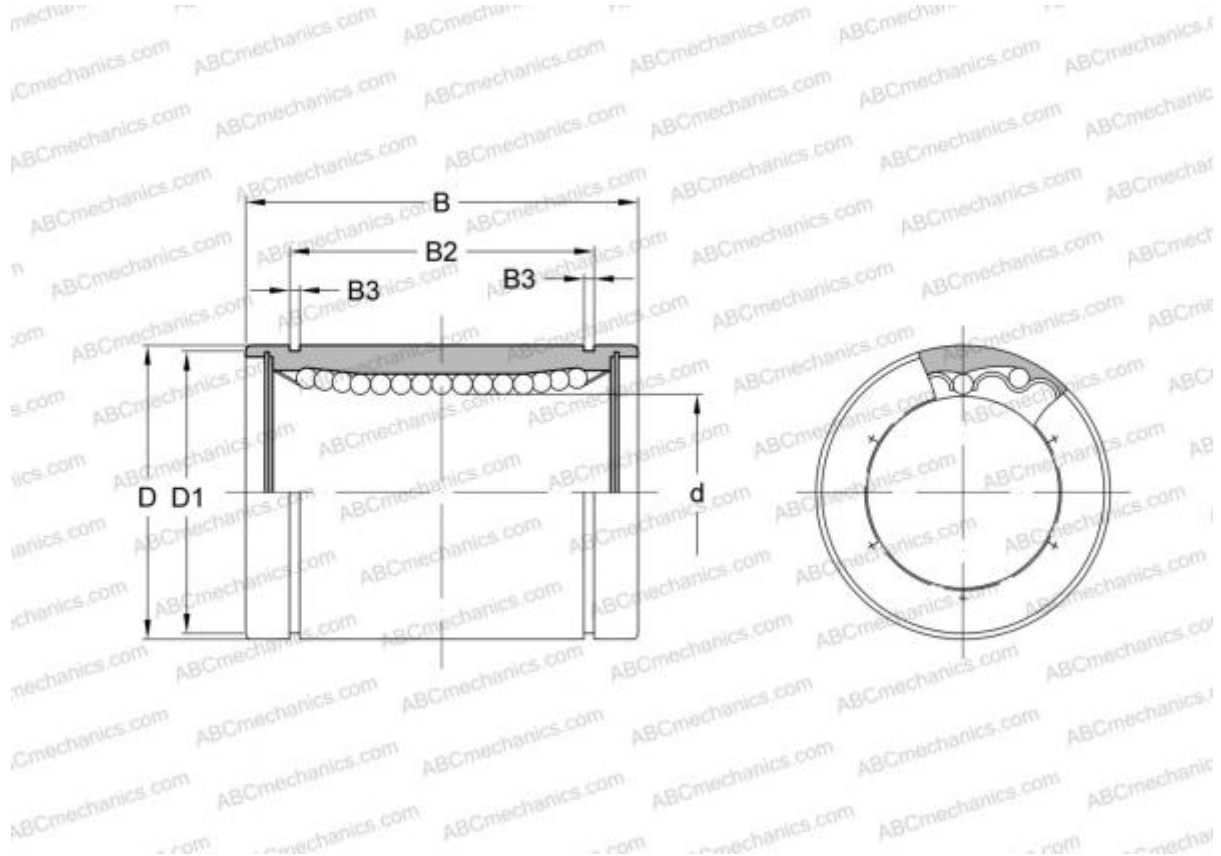

Technical specification

DIMENSIONS, MM

d	10,000
D	19,000
B	29,000

WEIGHT, KG 0,030

MANUFACTURER [IKO](#)

CALCULATION DATA

Basic dynamic load rating min	0,179 kN
Basic dynamic load rating max	0,206 kN
Basic static load rating min	0,354 kN
Basic static load rating max	0,501 kN