

LM 162837 UU AJ IKO

Linear bushing

TYPE: Shaft guidance systems, Linear bushing, Standard, Adjustable type, Type LM..(N) UU AJ, sealed on both sides (IKO)

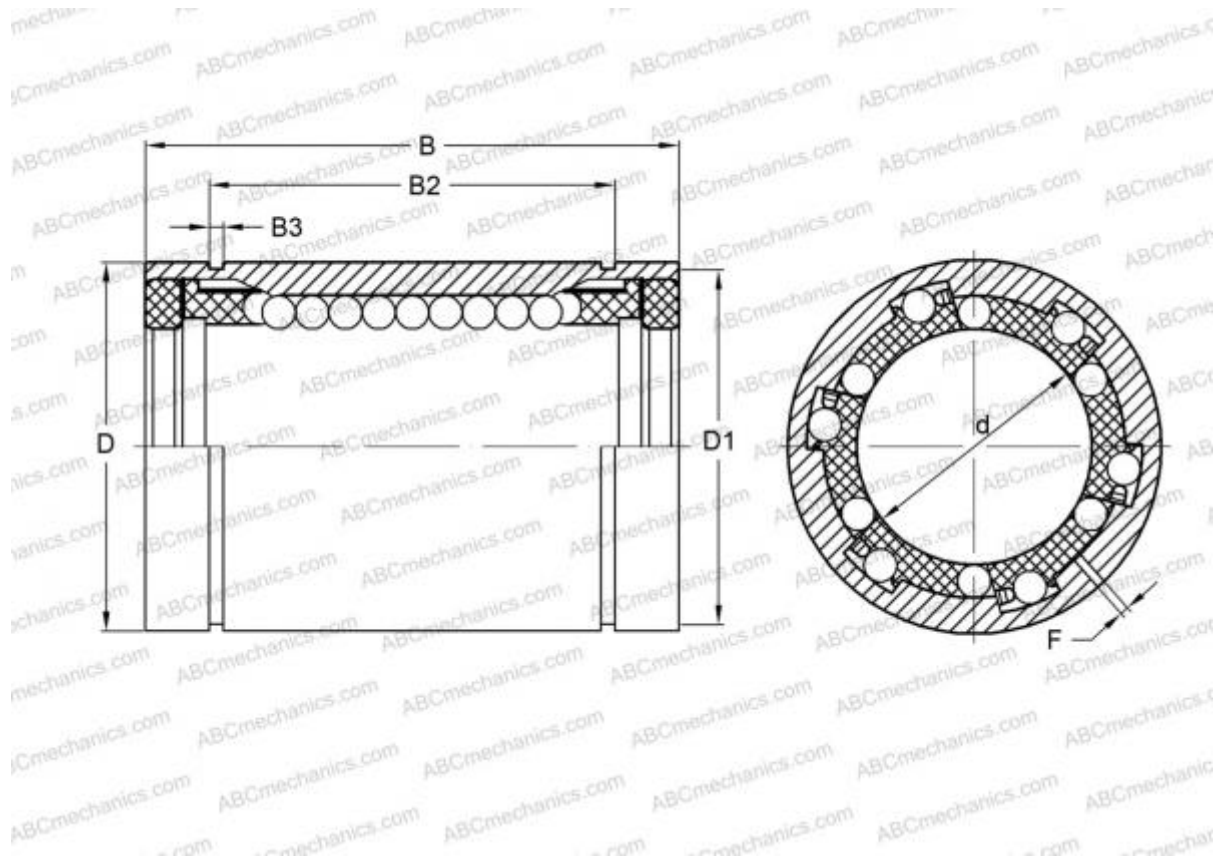

Technical specification

DIMENSIONS, MM

d	16,000
D	28,000
B	37,000
f	1,500

WEIGHT, KG 0,077

MANUFACTURER [IKO](#)

CALCULATION DATA

Basic dynamic load rating min	0,426 kN
Basic dynamic load rating max	0,489 kN
Basic static load rating min	0,766 kN
Basic static load rating max	1,080 kN