

## LM 100150175 UU AJ IKO

Linear bushing

TYPE: Shaft guidance systems, Linear bushing, Standard, Adjustable type, Type LM..(N) UU AJ, sealed on both sides (IKO)

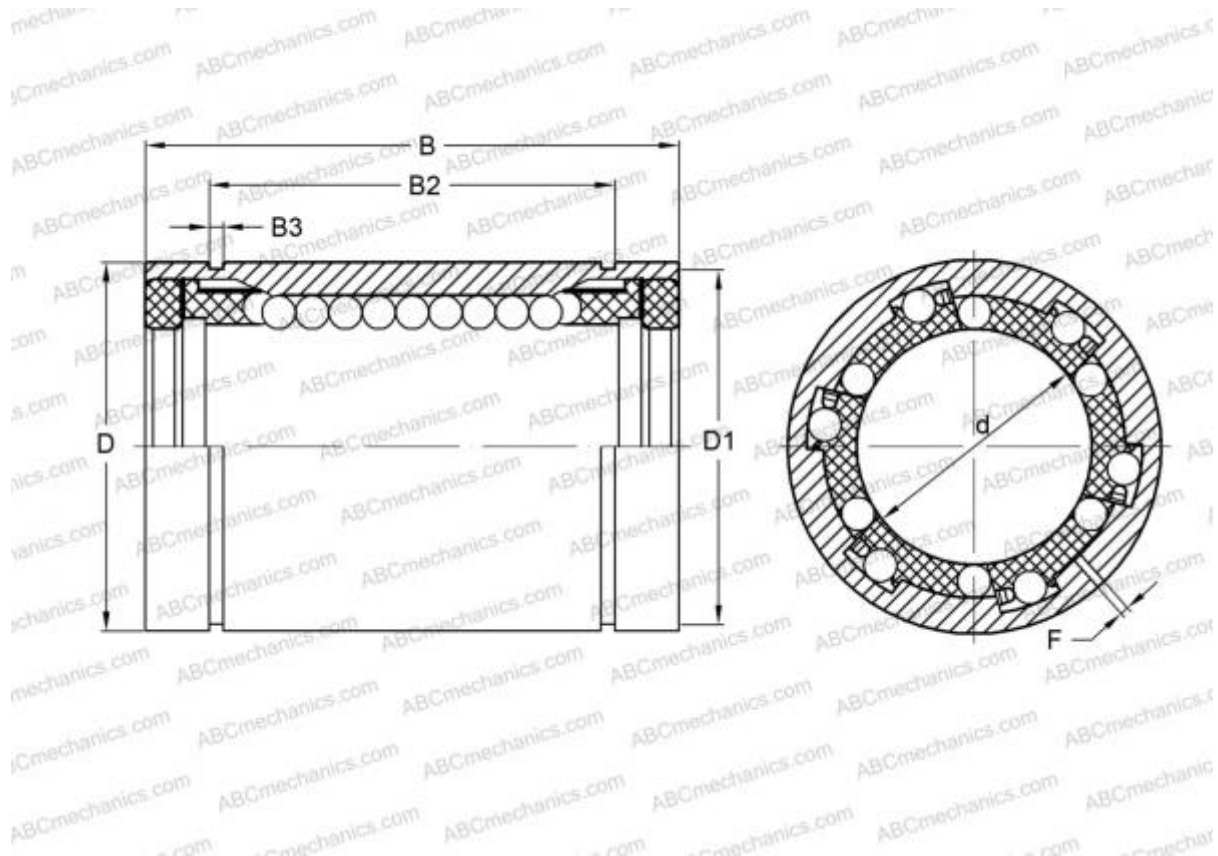

### Technical specification

#### DIMENSIONS, MM

d	100,000
D	150,000
B	175,000
f	3,000

**WEIGHT, KG** 8,540

**MANUFACTURER** [IKO](#)

#### CALCULATION DATA

Basic dynamic load rating min	14,500 kN
Basic dynamic load rating max	15,300 kN
Basic static load rating min	22,800 kN
Basic static load rating max	29,200 kN