

LM 100150175 UU OP IKO

Linear bushing

TYPE: Shaft guidance systems, Linear bushing, Standard, Open type for support rail, Type LM..(N) UU OP, sealed on both sides (IKO)

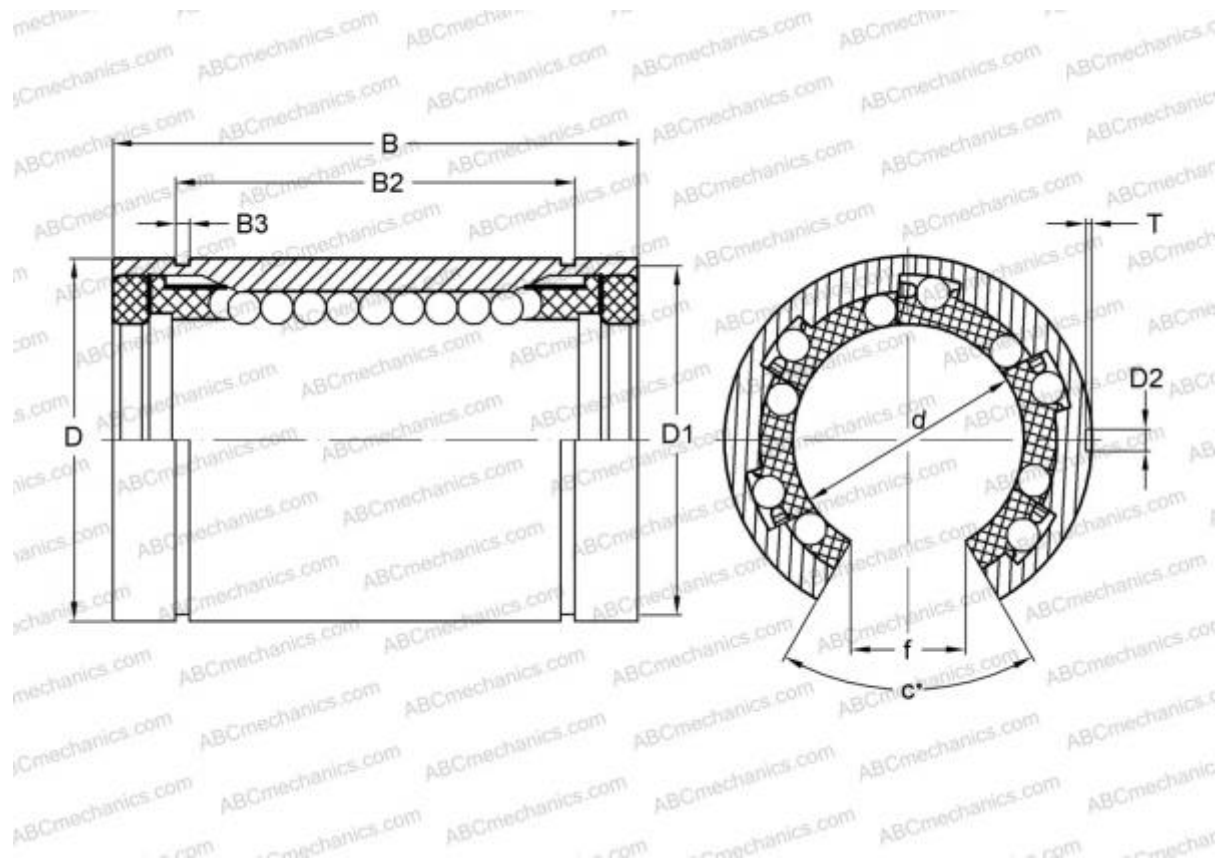

Technical specification

DIMENSIONS, MM

d	100,000
D	150,000
B	175,000
f	50,000
c	50

WEIGHT, KG 7,200

MANUFACTURER [IKO](#)

CALCULATION DATA

Basic dynamic load rating min	14,500 kN
Basic dynamic load rating max	15,300 kN
Basic static load rating min	22,800 kN
Basic static load rating max	29,200 kN