

## LM 132332 F IKO

Linear bushing

TYPE: Shaft guidance systems, Linear bushing, Standard, Close type, Type LM..(N) F, stainless steel (IKO)

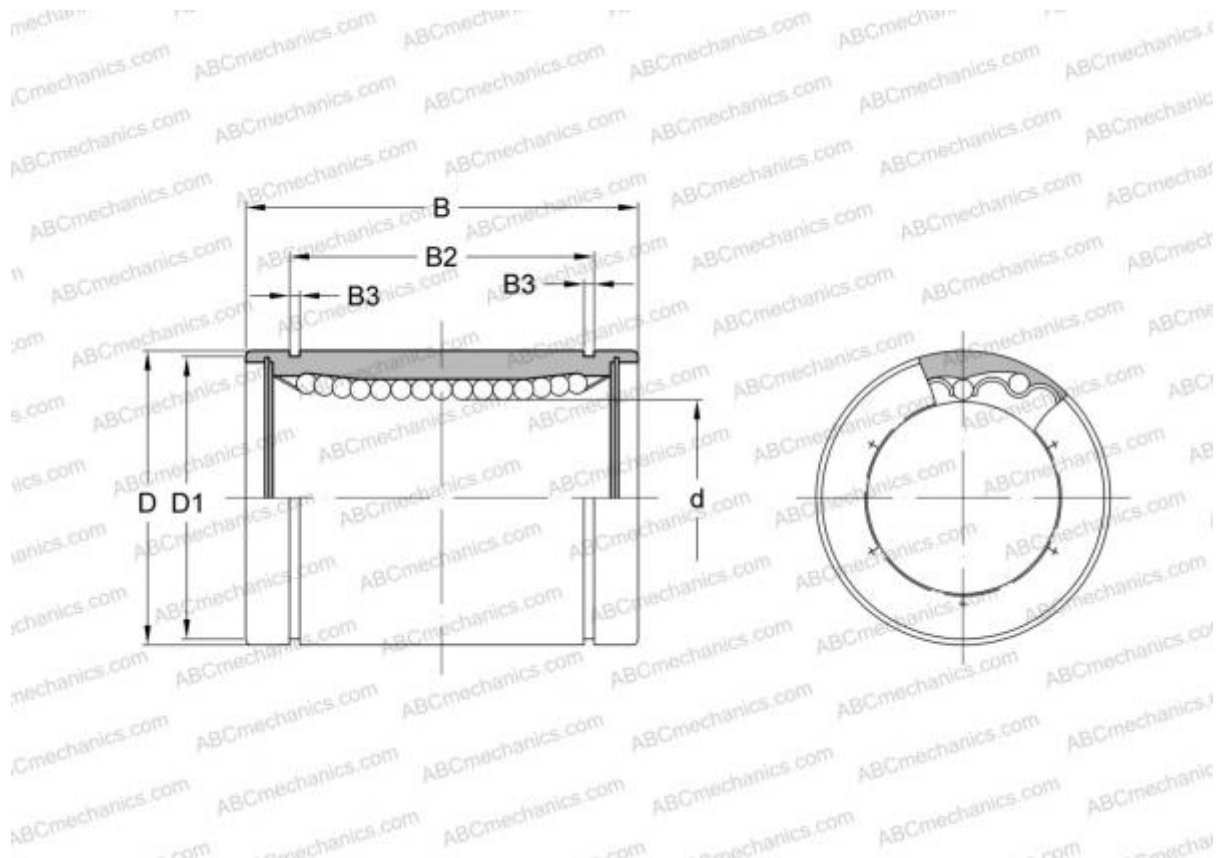

### Technical specification

#### DIMENSIONS, MM

d	13,000
D	23,000
B	32,000

**WEIGHT, KG** 0,049

**MANUFACTURER** [IKO](#)

#### CALCULATION DATA

Basic dynamic load rating min	0,266 kN
Basic dynamic load rating max	0,306 kN
Basic static load rating min	0,506 kN
Basic static load rating max	0,716 kN