

## LM 203242 F IKO

Linear bushing

TYPE: Shaft guidance systems, Linear bushing, Standard, Close type, Type LM..(N) F, stainless steel (IKO)

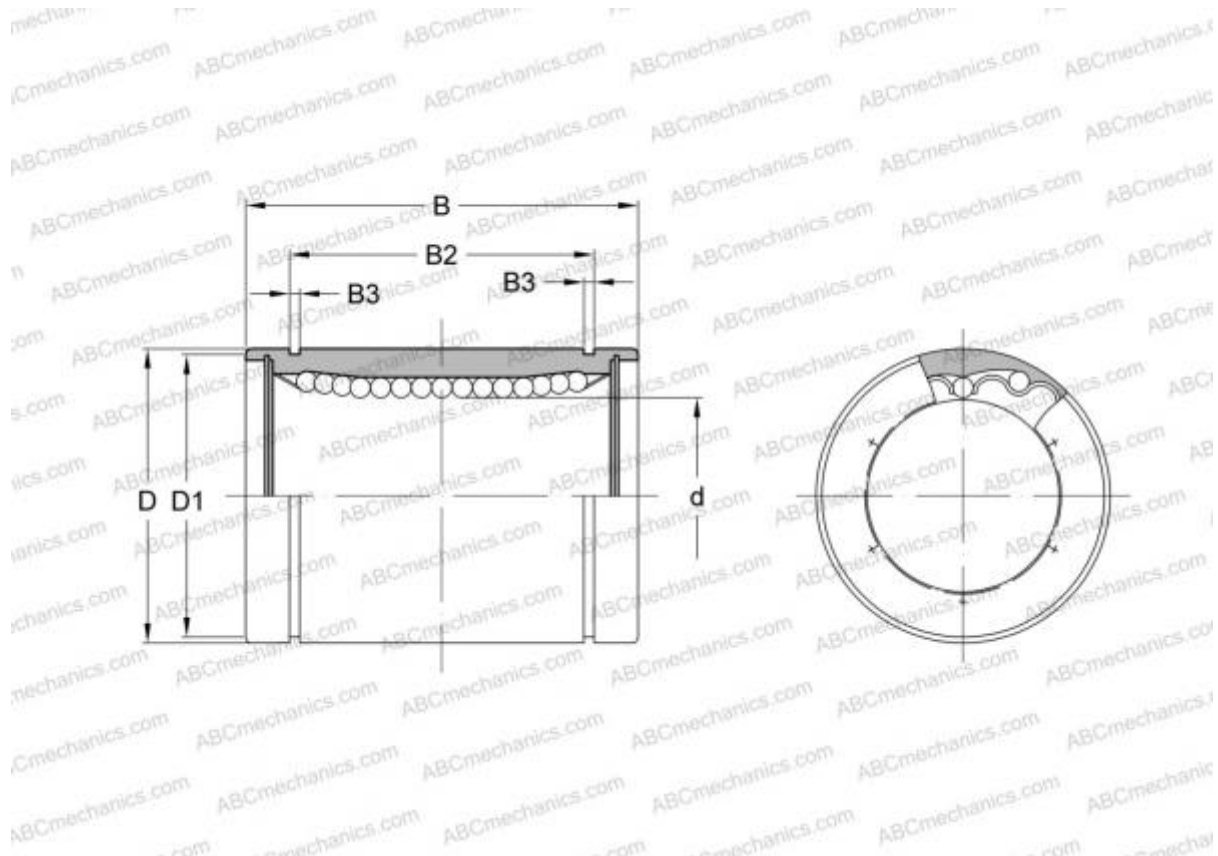

### Technical specification

#### DIMENSIONS, MM

d	20,000
D	32,000
B	42,000

**WEIGHT, KG** 0,100

**MANUFACTURER** [IKO](#)

#### CALCULATION DATA

Basic dynamic load rating min	0,562 kN
Basic dynamic load rating max	0,668 kN
Basic static load rating min	1,010 kN
Basic static load rating max	1,470 kN