

LM 122130 F UU IKO

Linear bushing

TYPE: Shaft guidance systems, Linear bushing, Standard, Close type, Type LM..(N) F UU, stainless steel, sealed on both sides (IKO)

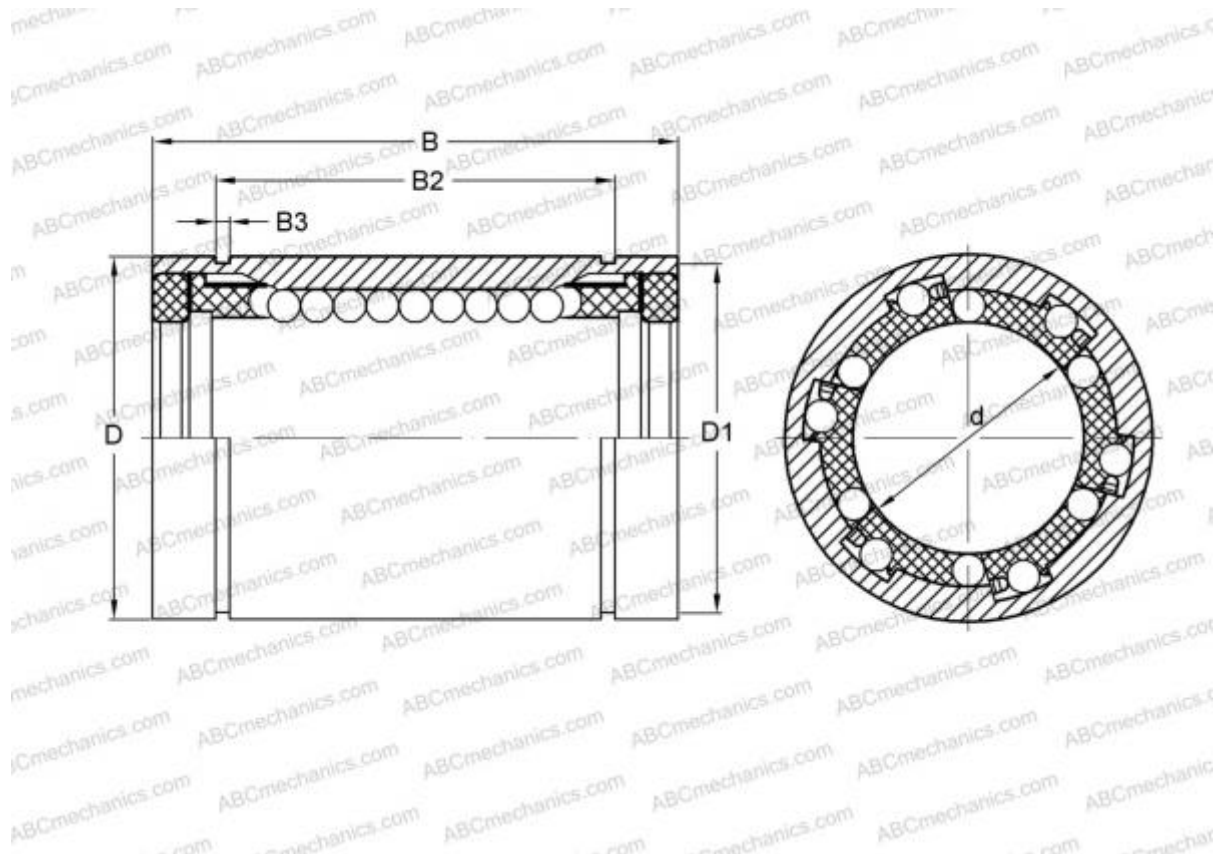

Technical specification

DIMENSIONS, MM

d	12,000
D	21,000
B	30,000

WEIGHT, KG 0,041

MANUFACTURER [IKO](#)

CALCULATION DATA

Basic dynamic load rating min	0,259 kN
Basic dynamic load rating max	0,298 kN
Basic static load rating min	0,503 kN
Basic static load rating max	0,711 kN