

LM 406080 F AJ IKO

Linear bushing

TYPE: Shaft guidance systems, Linear bushing, Standard, Adjustable type, Type LM..(N) AJ, stainless steel (IKO)

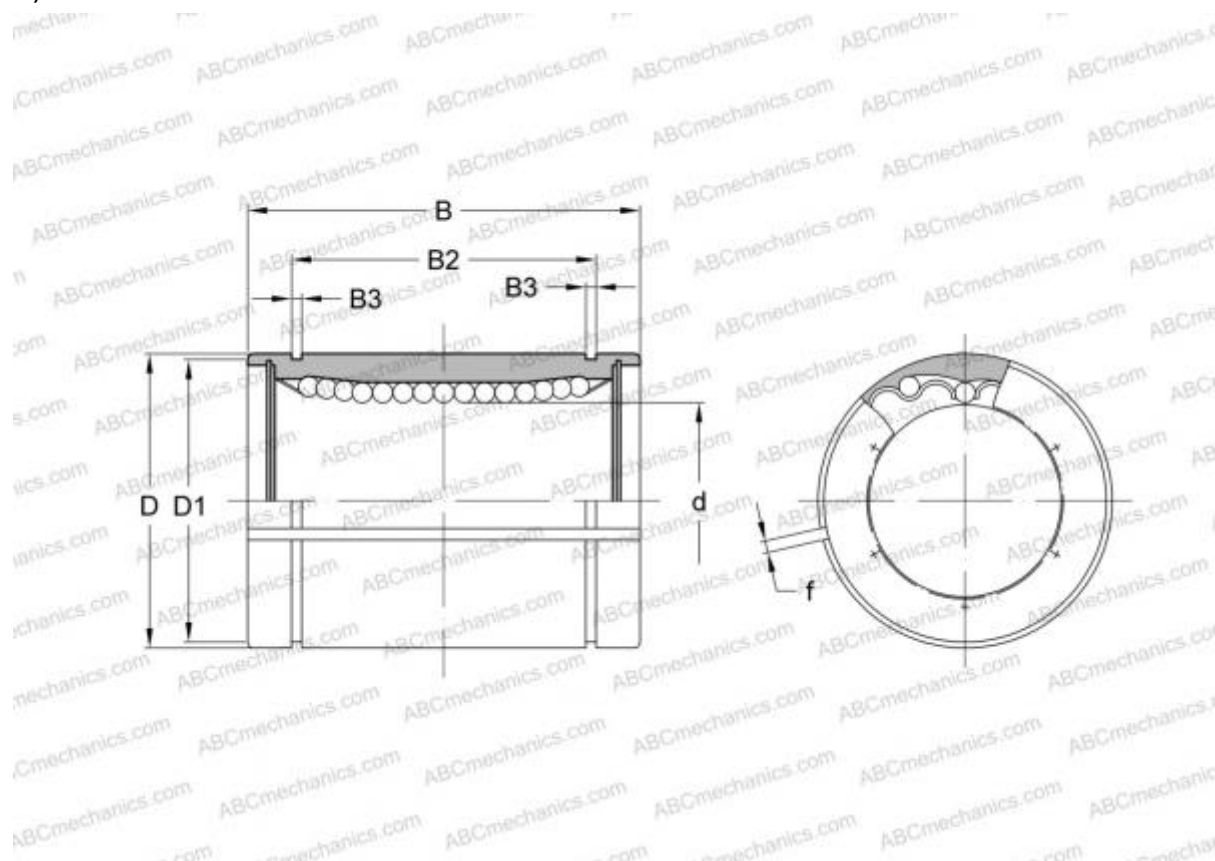

Technical specification

DIMENSIONS, MM

d	40,000
D	60,000
B	80,000
f	3,000

WEIGHT, KG 0,654

MANUFACTURER [IKO](#)

CALCULATION DATA

Basic dynamic load rating min	2,030 kN
Basic dynamic load rating max	2,150 kN
Basic static load rating min	3,620 kN
Basic static load rating max	4,640 kN