

LM 132332 F UU AJ IKO

Linear bushing

TYPE: Shaft guidance systems, Linear bushing, Standard, Adjustable type, Type LM..(N) F UU AJ, stainless steel, sealed on both sides (IKO)

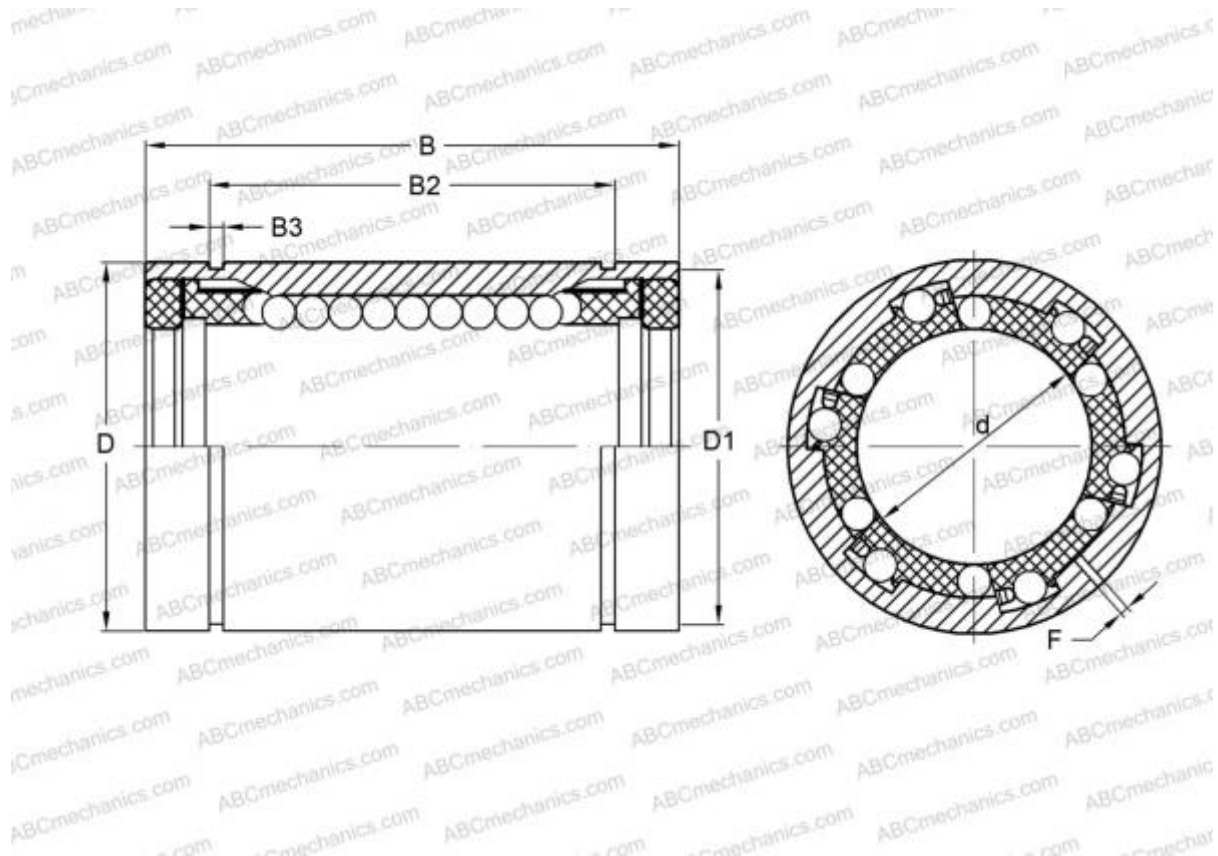

Technical specification

DIMENSIONS, MM

d	13,000
D	23,000
B	32,000
f	1,500

WEIGHT, KG 0,048

MANUFACTURER [IKO](#)

CALCULATION DATA

Basic dynamic load rating min	0,266 kN
Basic dynamic load rating max	0,306 kN
Basic static load rating min	0,506 kN
Basic static load rating max	0,716 kN