

## LM 101929 N F UU OP IKO

Linear bushing

TYPE: Shaft guidance systems, Linear bushing, Standard, Open type for support rail, Type LM..(N) F UU OP, stainless steel, sealed on both sides (IKO)

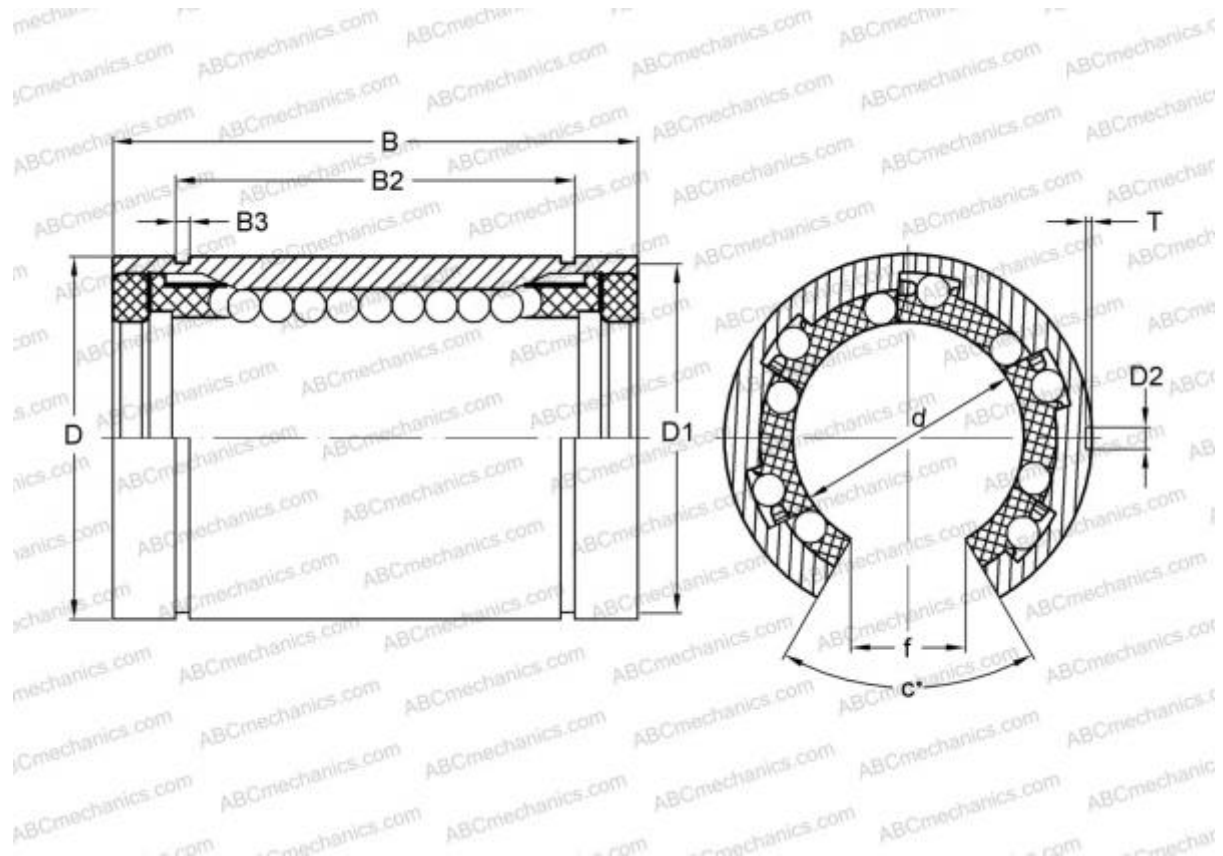

### Technical specification

#### DIMENSIONS, MM

d	10,000
D	19,000
B	29,000
f	8,000
c	80

**WEIGHT, KG** 0,023

**MANUFACTURER** [IKO](#)

#### CALCULATION DATA

Basic dynamic load rating min	0,179 kN
Basic dynamic load rating max	0,206 kN
Basic static load rating min	0,354 kN
Basic static load rating max	0,501 kN