

## LM 122130 N F UU OP IKO

Linear bushing

TYPE: Shaft guidance systems, Linear bushing, Standard, Open type for support rail, Type LM..(N) F UU OP, stainless steel, sealed on both sides (IKO)

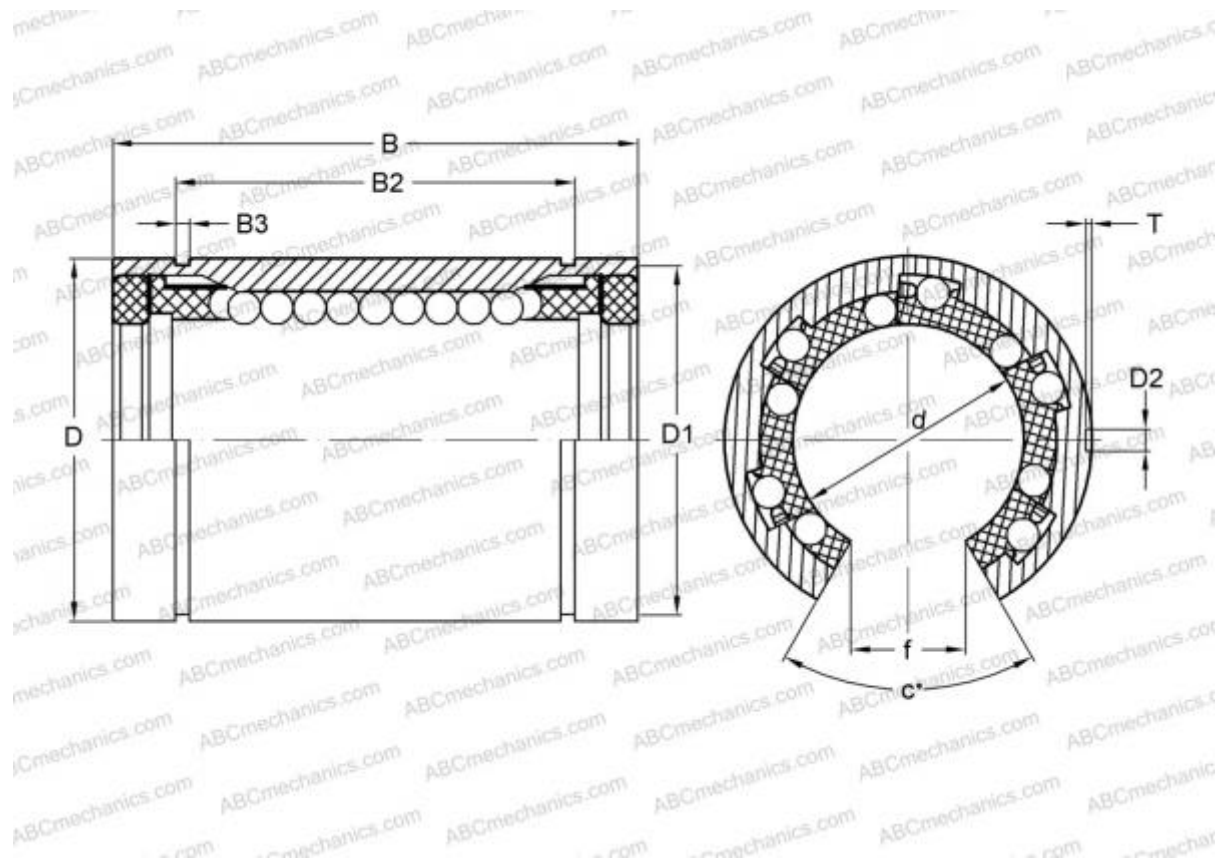

### Technical specification

#### DIMENSIONS, MM

d	12,000
D	21,000
B	30,000
f	8,000
c	80

**WEIGHT, KG** 0,025

**MANUFACTURER** [IKO](#)

#### CALCULATION DATA

Basic dynamic load rating min	0,259 kN
Basic dynamic load rating max	0,298 kN
Basic static load rating min	0,503 kN
Basic static load rating max	0,711 kN