

## LM 162837 F UU OP IKO

Linear bushing

TYPE: Shaft guidance systems, Linear bushing, Standard, Open type for support rail, Type LM..(N) F UU OP, stainless steel, sealed on both sides (IKO)

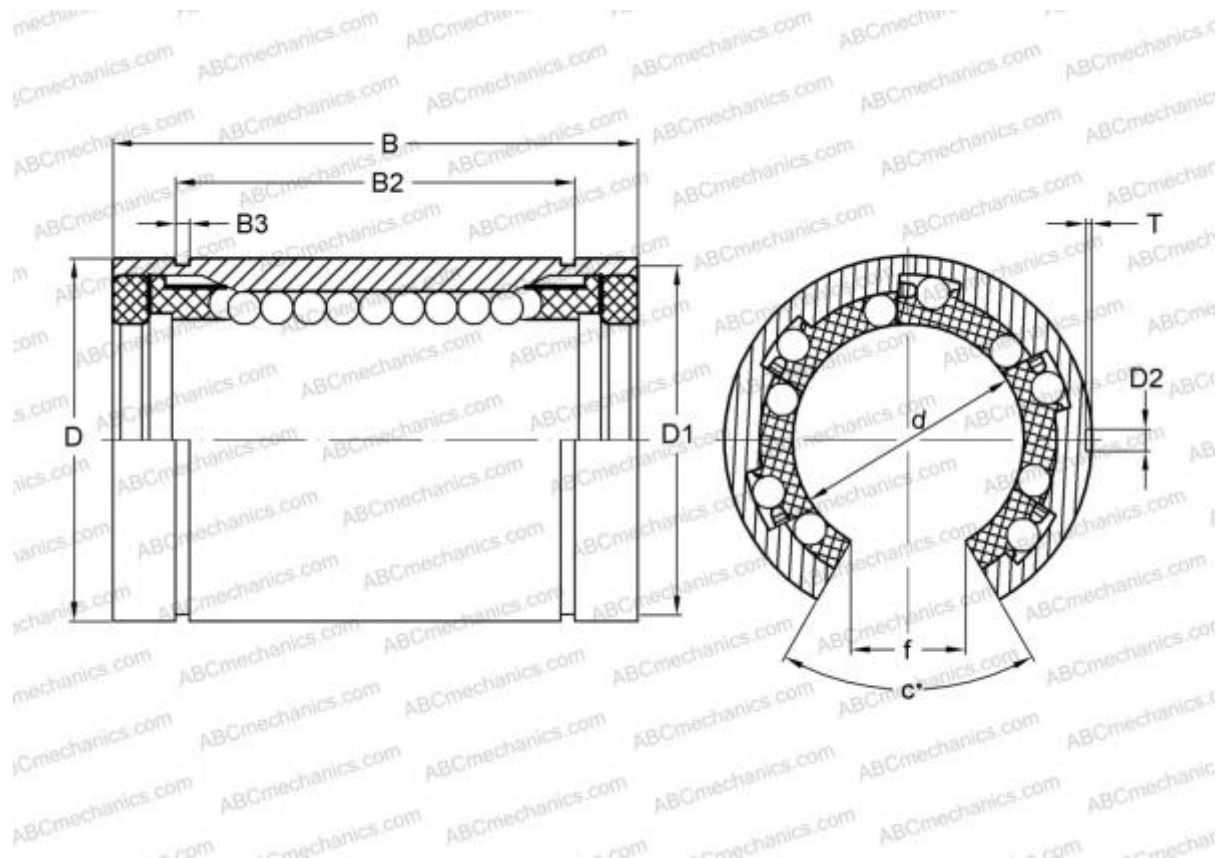

### Technical specification

#### DIMENSIONS, MM

d	16,000
D	28,000
B	37,000
f	11,000
c	80

**WEIGHT, KG** 0,060

**MANUFACTURER** [IKO](#)

#### CALCULATION DATA

Basic dynamic load rating min	0,426 kN
Basic dynamic load rating max	0,489 kN
Basic static load rating min	0,766 kN
Basic static load rating max	1,080 kN