

SMS 8G-AJ NB

Linear bushing

TYPE: Shaft guidance systems, Linear bushing, Standard, Adjustable type, Type SM..AJ, Asian standard, Corrosion resistance, Plastic cage (NB)

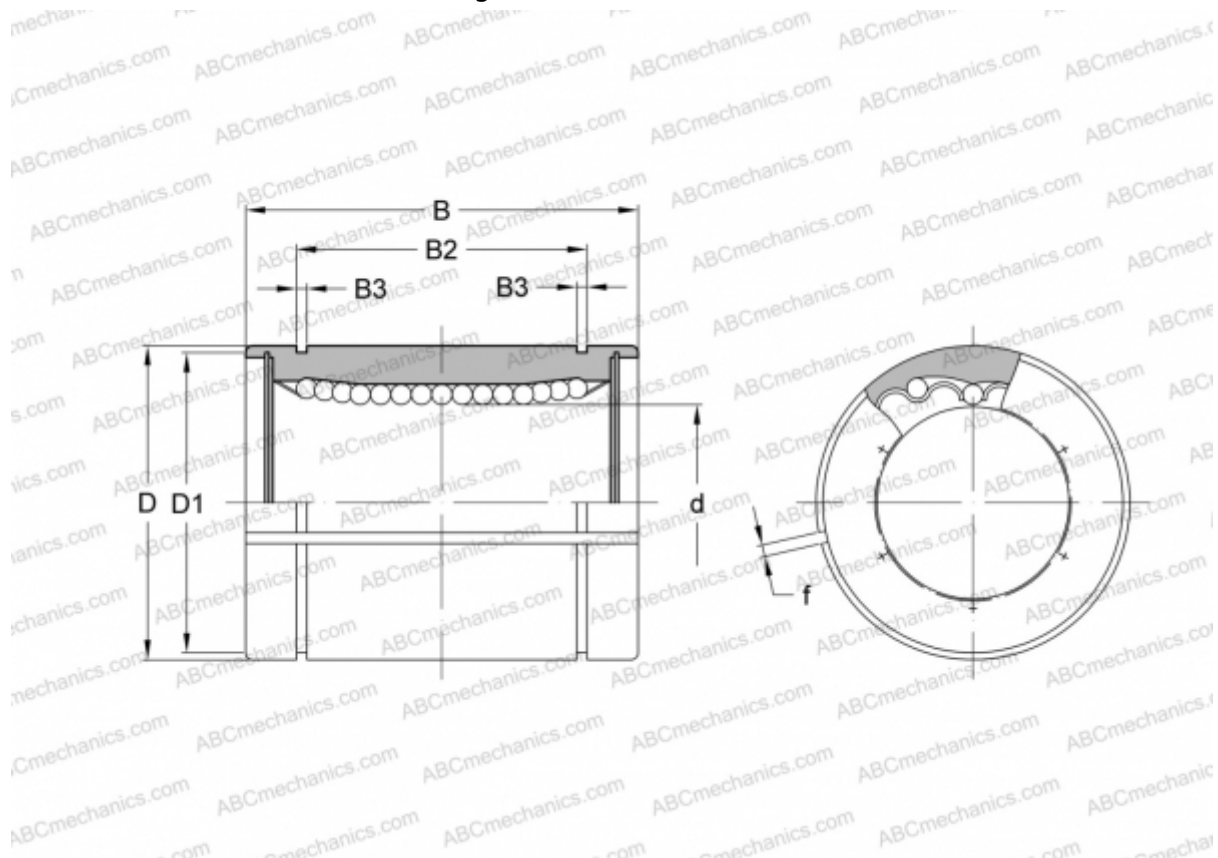

Technical specification

DIMENSIONS, MM

d	8,000
D	15,000
B	24,000
D1	14,300
B2	17,500
B3	1,100
f	1,000

WEIGHT, KG 0,015

MANUFACTURER [NB](#)