

0610-016-00 THOMSON

Linear bushing

TYPE: Shaft guidance systems, Linear bushing, Standard, Adjustable type, Type LME..(N) AJ

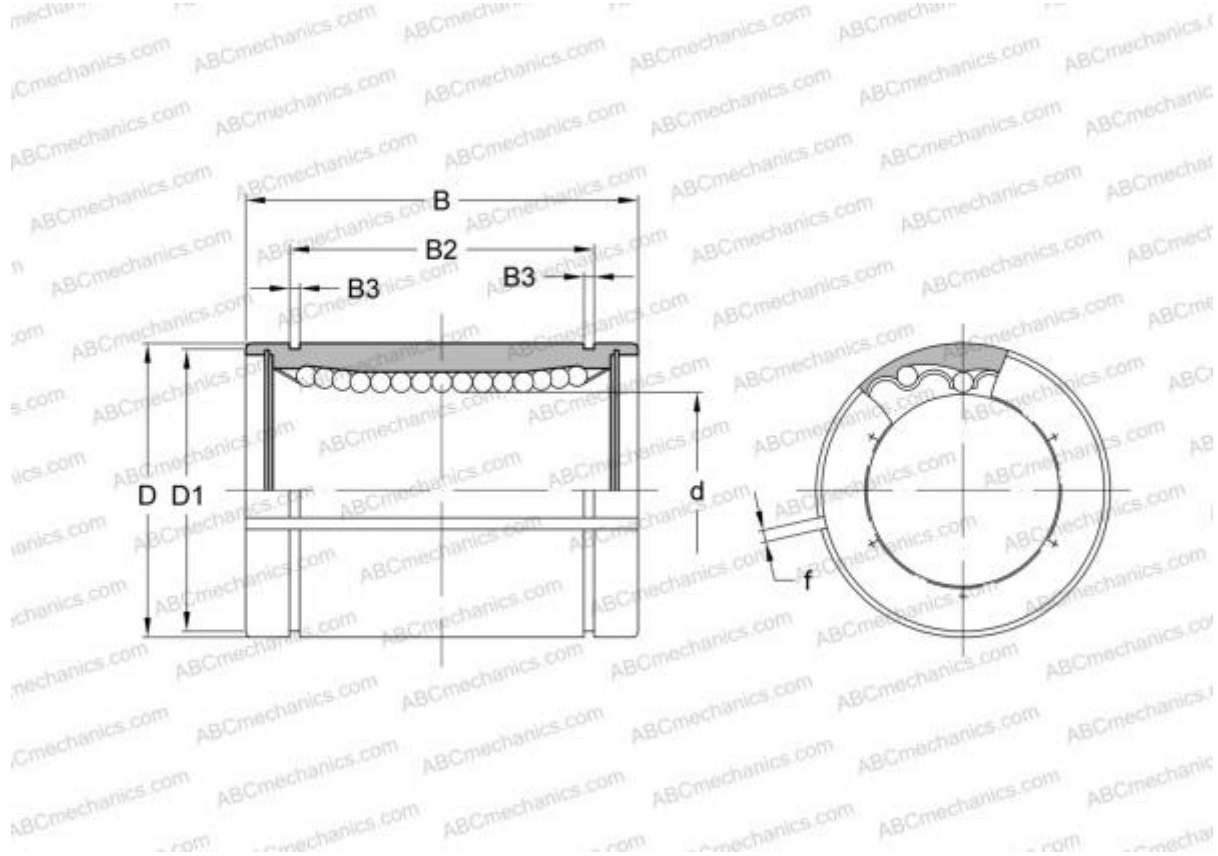

Technical specification

DIMENSIONS, MM

d	16,000
D	26,000
B	36,000
f	1,500

WEIGHT, KG 0,058

MANUFACTURER [THOMSON](#)

INTERCHANGE

ABC	LME 162636 AJ
IKO	LME 162636 AJ
STAR	0610-016-00