

LME 203245 AJ IKO

Linear bushing

TYPE: Shaft guidance systems, Linear bushing, Standard, Adjustable type, Type LME..(N) AJ

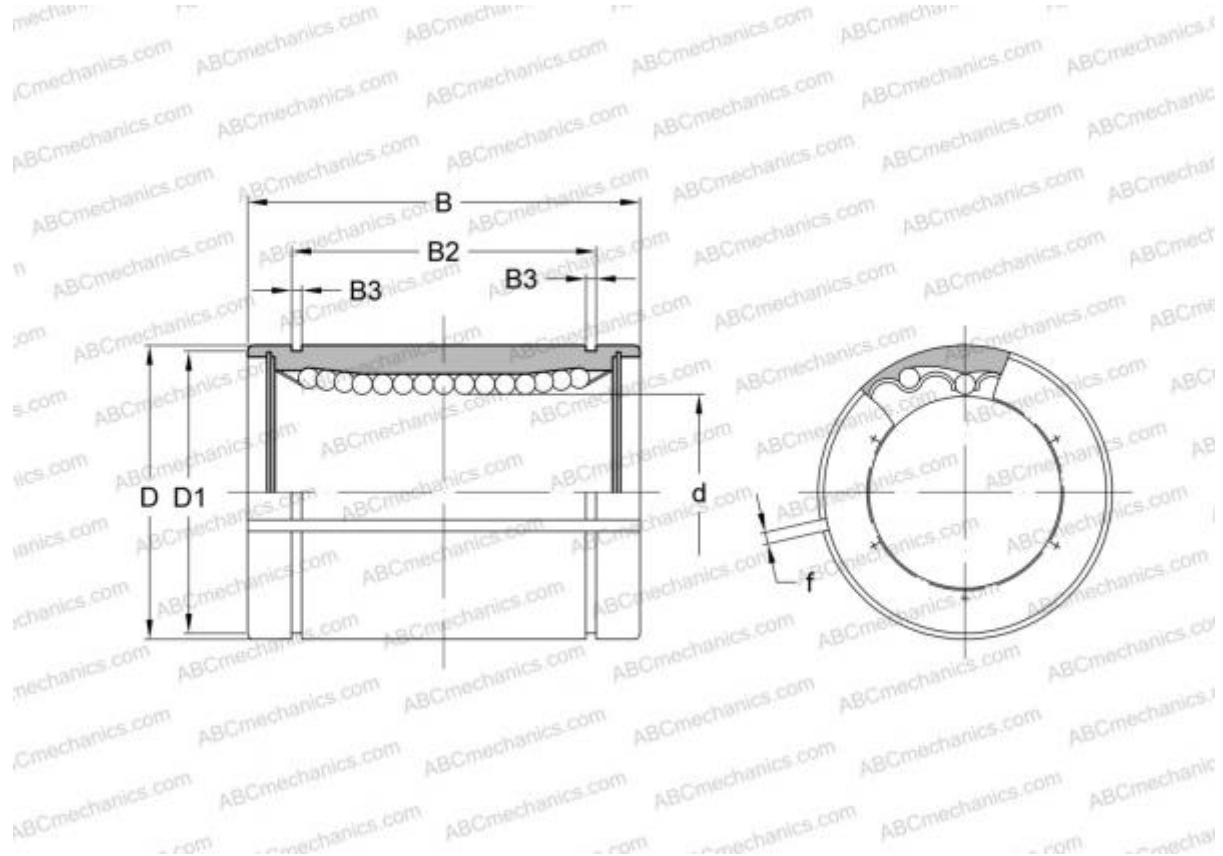

Technical specification

DIMENSIONS, MM

d	20,000
D	32,000
B	45,000
f	2,000

WEIGHT, KG 0,100

MANUFACTURER [IKO](#)

INTERCHANGE

ABC	LME 203245 AJ
STAR	0610-020-00
THOMSON	0610-020-00

CALCULATION DATA

Basic dynamic load rating min	0,562 kN
Basic dynamic load rating max	0,668 kN

CALCULATION DATA

Basic static load rating min	1,010 kN
Basic static load rating max	1,470 kN