

0610-020-00 STAR

Linear bushing

TYPE: Shaft guidance systems, Linear bushing, Standard, Adjustable type, Type LME..(N) AJ

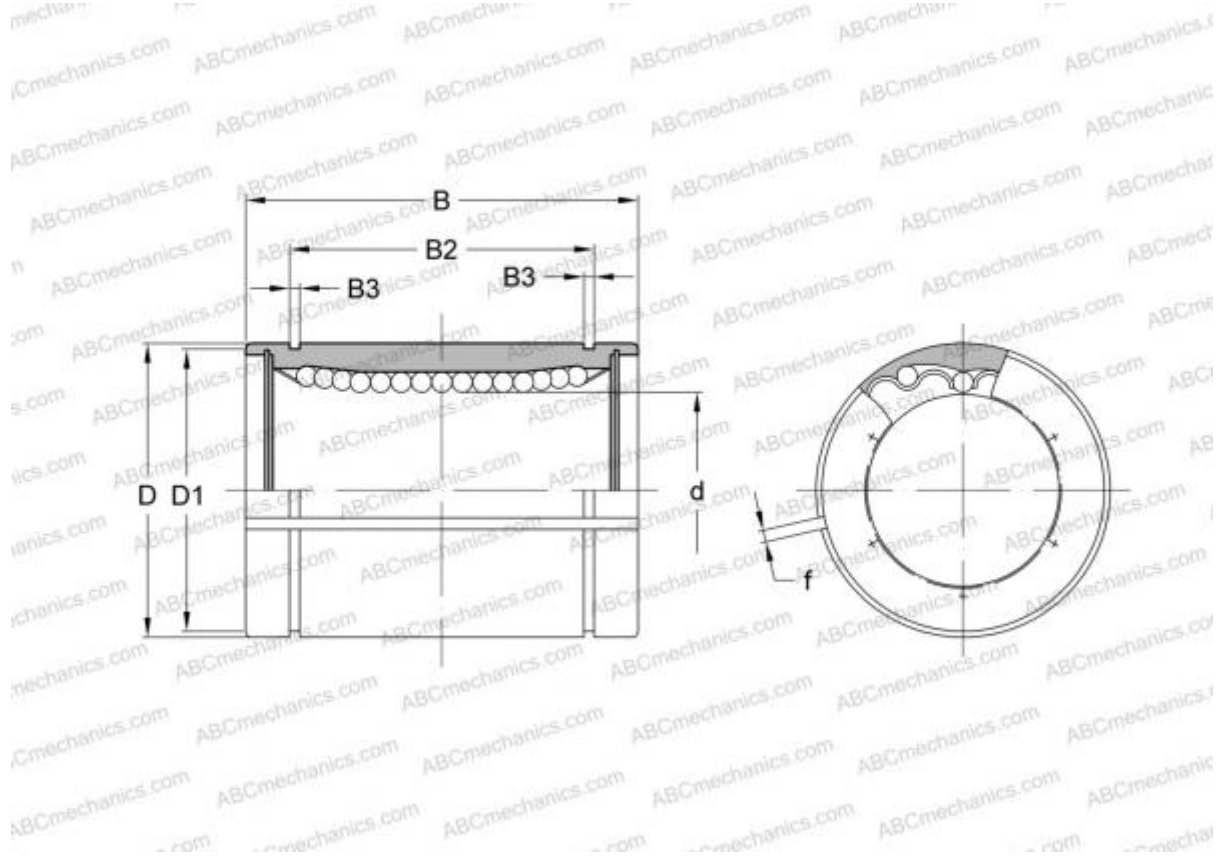

Technical specification

DIMENSIONS, MM

d	20,000
D	32,000
B	45,000
f	2,000

WEIGHT, KG 0,100

MANUFACTURER [STAR](#)

INTERCHANGE

ABC	LME 203245 AJ
IKO	LME 203245 AJ
THOMSON	0610-020-00