

0610-025-00 STAR

Linear bushing

TYPE: Shaft guidance systems, Linear bushing, Standard, Adjustable type, Type LME..(N) AJ

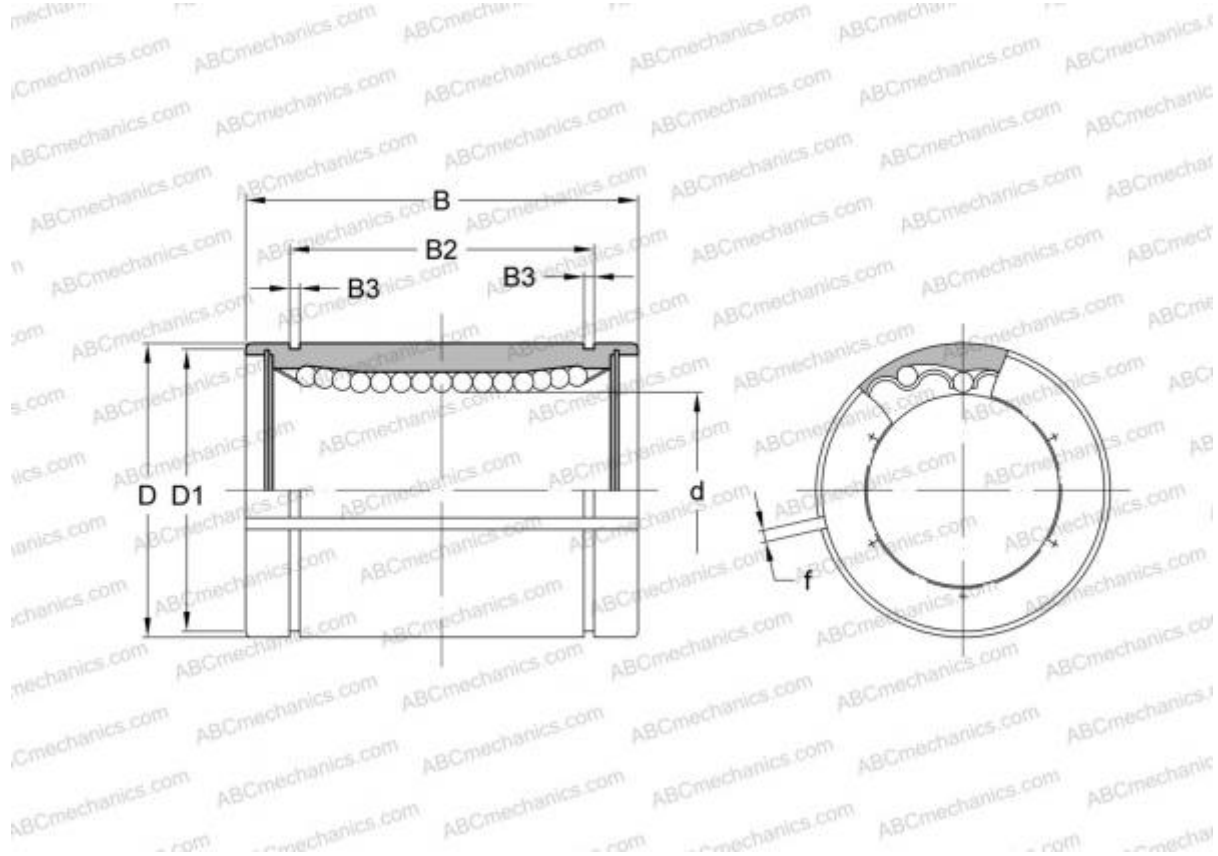

Technical specification

DIMENSIONS, MM

d	25,000
D	40,000
B	58,000
f	2,000

WEIGHT, KG 0,235

MANUFACTURER [STAR](#)

INTERCHANGE

ABC	LME 254058 AJ
IKO	LME 254058 AJ
THOMSON	0610-025-00