

LME 304768 AJ IKO

Linear bushing

TYPE: Shaft guidance systems, Linear bushing, Standard, Adjustable type, Type LME..(N) AJ

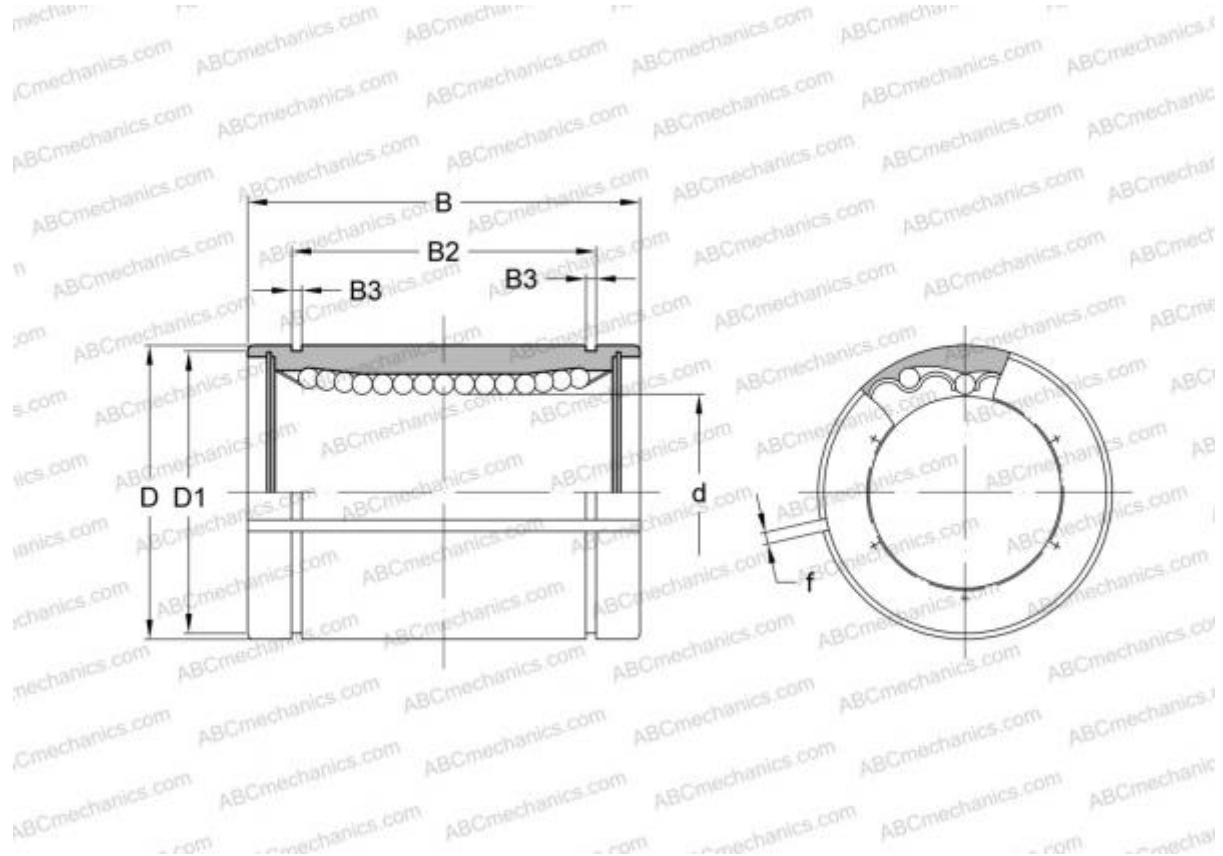

Technical specification

DIMENSIONS, MM

d	30,000
D	47,000
B	68,000
f	2,000

WEIGHT, KG 0,355

MANUFACTURER [IKO](#)

INTERCHANGE

ABC	LME 304768 AJ
STAR	0610-030-00
THOMSON	0610-030-00

CALCULATION DATA

Basic dynamic load rating min	1,350 kN
Basic dynamic load rating max	1,430 kN

CALCULATION DATA

Basic static load rating min	2,500 kN
Basic static load rating max	3,200 kN