

## LME 122232 OP ABC

Linear bushing

TYPE: Shaft guidance systems, Linear bushing, Standard, Open type for support rail, Type LME..(N) OP

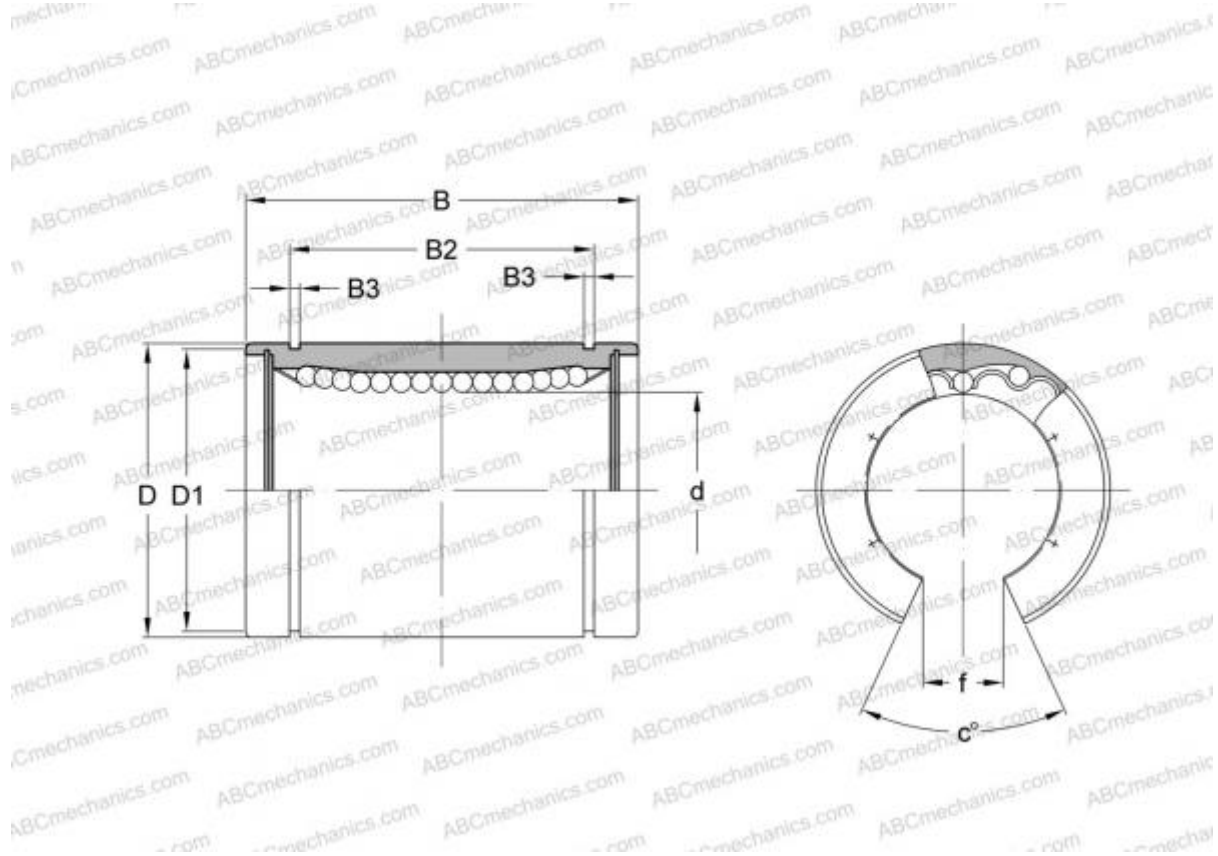

### Technical specification

#### DIMENSIONS, MM

d	12,000
D	22,000
B	32,000
f	7,500
c	78,000

**WEIGHT, KG** 0,035

**MANUFACTURER** [ABC](#)

#### INTERCHANGE

IKO	<a href="#">LME 122232 OP</a>
STAR	<a href="#">0630-012-00</a>
THOMSON	<a href="#">0630-012-00</a>