

0630-012-00 STAR

Linear bushing

TYPE: Shaft guidance systems, Linear bushing, Standard, Open type for support rail, Type LME..(N) OP

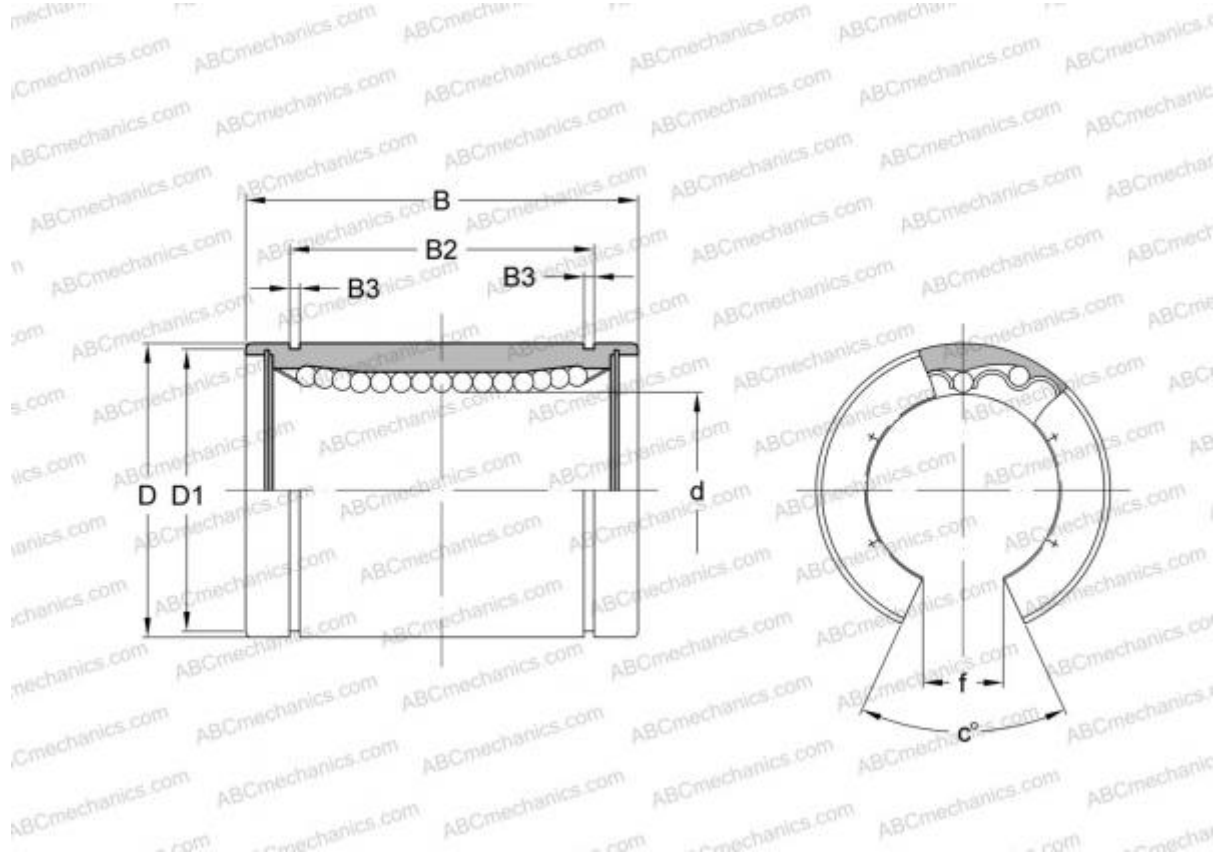

Technical specification

DIMENSIONS, MM

d	12,000
D	22,000
B	32,000
f	7,500
c	78,000

WEIGHT, KG 0,035

MANUFACTURER [STAR](#)

INTERCHANGE

ABC	LME 122232 OP
IKO	LME 122232 OP
THOMSON	0630-012-00