

## LME 203245 OP ABC

Linear bushing

TYPE: Shaft guidance systems, Linear bushing, Standard, Open type for support rail, Type LME..(N) OP

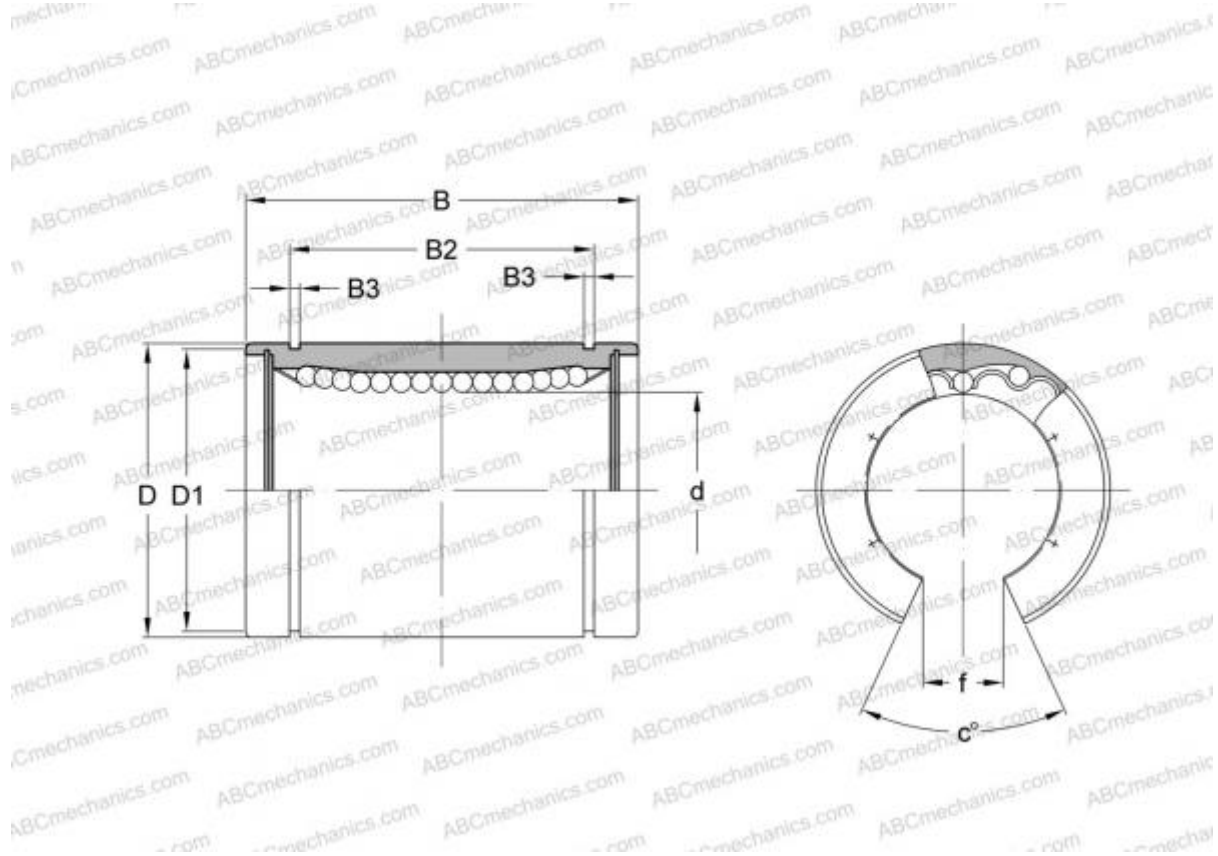

### Technical specification

#### DIMENSIONS, MM

d	20,000
D	32,000
B	45,000
f	10,000
c	60,000

**WEIGHT, KG** 0,084

**MANUFACTURER** [ABC](#)

#### INTERCHANGE

IKO	<a href="#">LME 203245 OP</a>
STAR	<a href="#">0630-020-00</a>
THOMSON	<a href="#">0630-020-00</a>