

0630-020-00 STAR

Linear bushing

TYPE: Shaft guidance systems, Linear bushing, Standard, Open type for support rail, Type LME..(N) OP

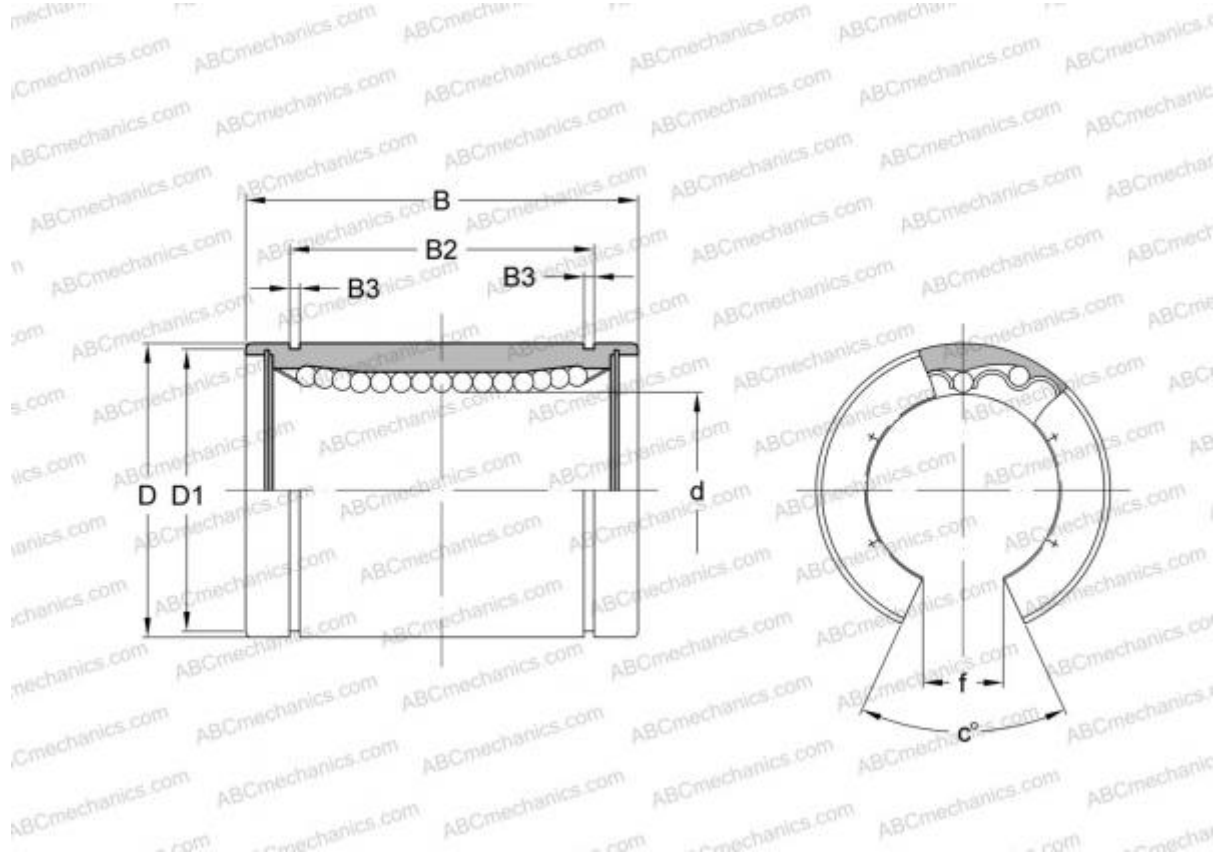

Technical specification

DIMENSIONS, MM

d	20,000
D	32,000
B	45,000
f	10,000
c	60,000

WEIGHT, KG 0,084

MANUFACTURER [STAR](#)

INTERCHANGE

ABC	LME 203245 OP
IKO	LME 203245 OP
THOMSON	0630-020-00