

0630-025-00 STAR

Linear bushing

TYPE: Shaft guidance systems, Linear bushing, Standard, Open type for support rail, Type LME..(N) OP

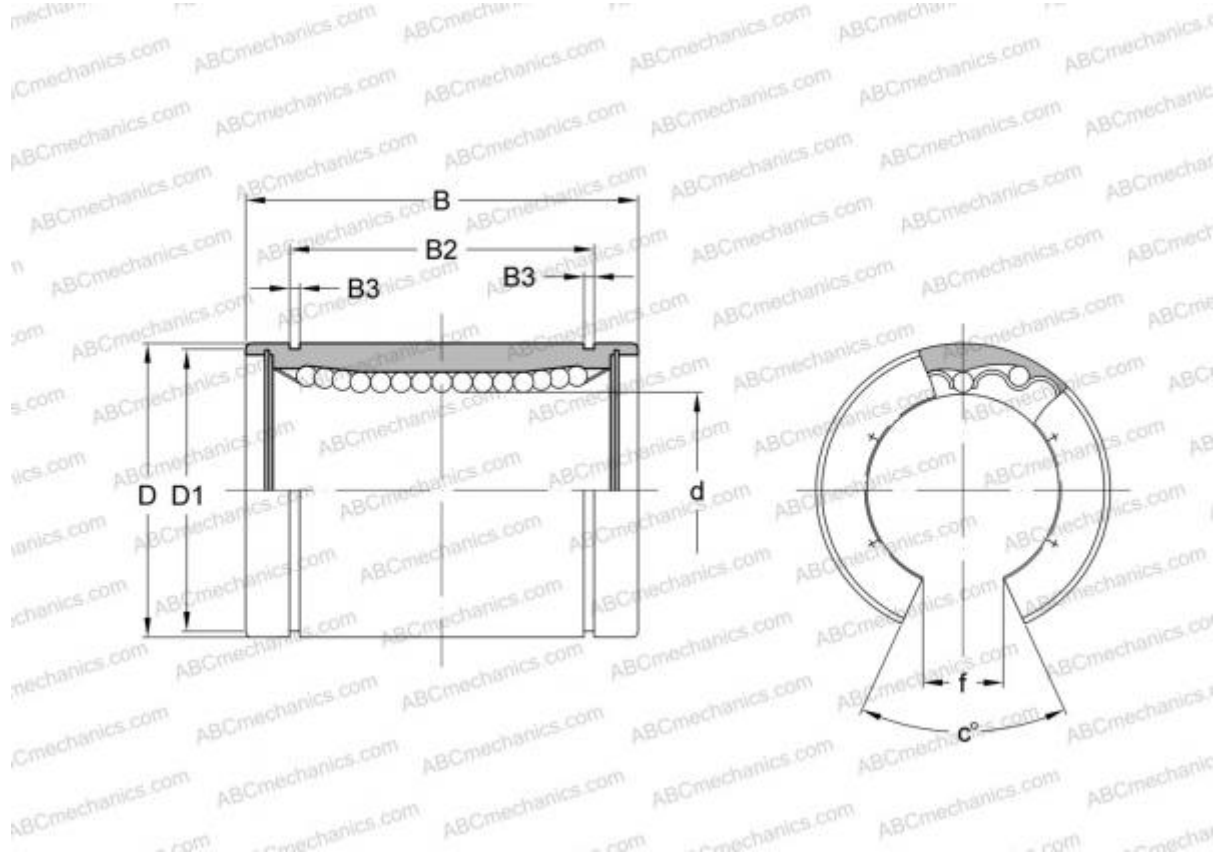

Technical specification

DIMENSIONS, MM

d	25,000
D	40,000
B	58,000
f	12,500
c	60,000

WEIGHT, KG 0,200

MANUFACTURER [STAR](#)

INTERCHANGE

ABC	LME 254058 OP
IKO	LME 254058 OP
THOMSON	0630-025-00