

## 0630-025-00 THOMSON

Linear bushing

TYPE: Shaft guidance systems, Linear bushing, Standard, Open type for support rail, Type LME..(N) OP

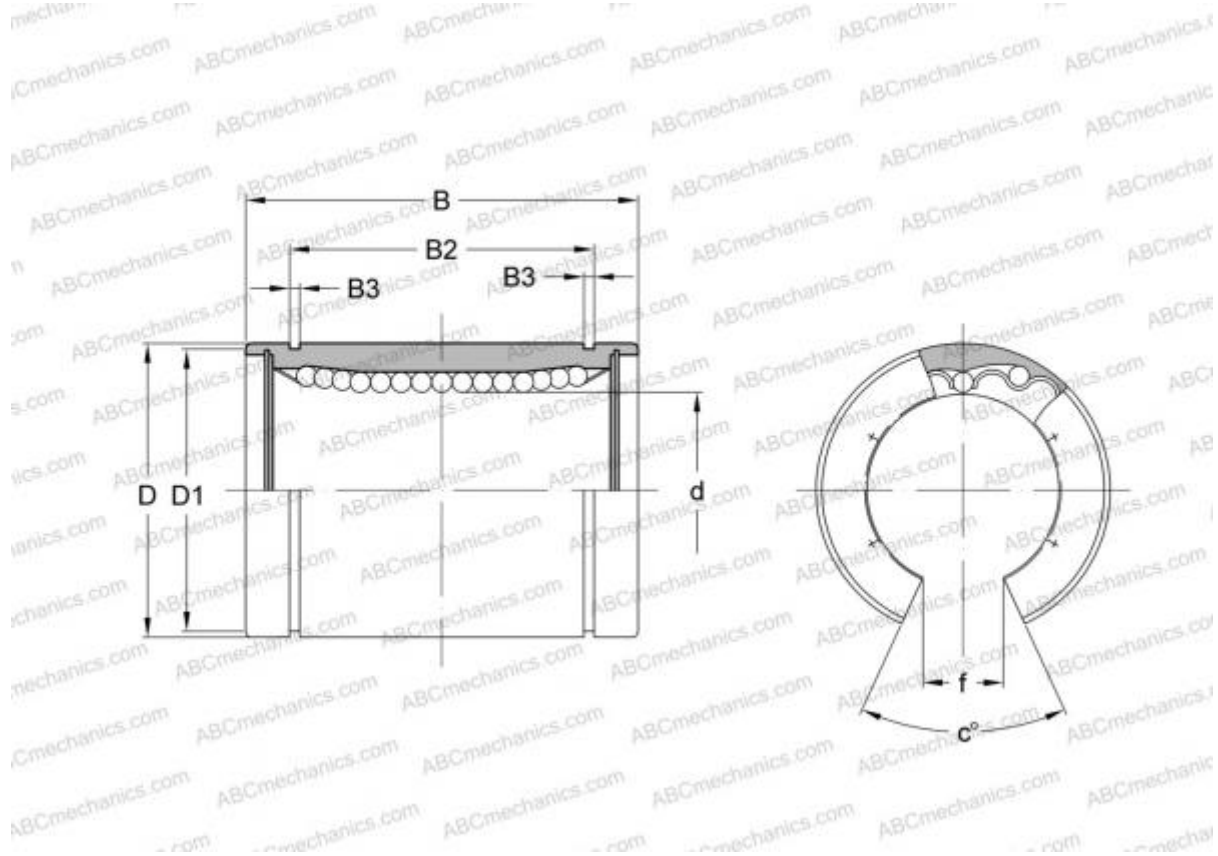

### Technical specification

#### DIMENSIONS, MM

d	25,000
D	40,000
B	58,000
f	12,500
c	60,000

**WEIGHT, KG** 0,200

**MANUFACTURER** [THOMSON](#)

#### INTERCHANGE

ABC	<a href="#">LME 254058 OP</a>
IKO	<a href="#">LME 254058 OP</a>
STAR	<a href="#">0630-025-00</a>