

SM 12G-OP NB

Linear bushing

TYPE: Shaft guidance systems, Linear bushing, Standard, Open type for support rail, Type SM..OP, Asian standard, Plastic cage (NB)

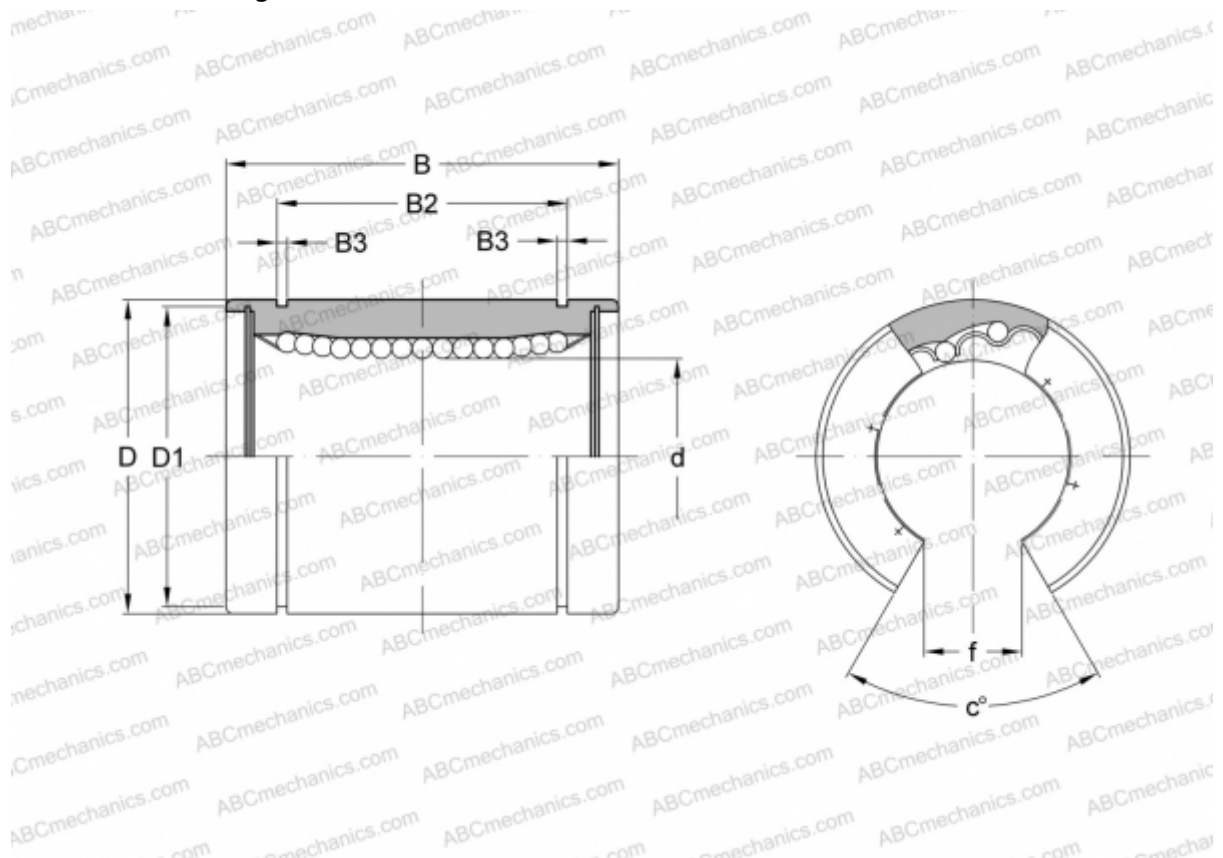

Technical specification

DIMENSIONS, MM

d	12,000
D	21,000
B	30,000
D1	20,000
B2	23,000
B3	1,300
f	8,000
c	80

WEIGHT, KG 0,032

MANUFACTURER [NB](#)