

LME 203245 UU IKO

Linear bushing

TYPE: Shaft guidance systems, Linear bushing, Standard, Close type, Type LME..(N) UU, sealed on both sides

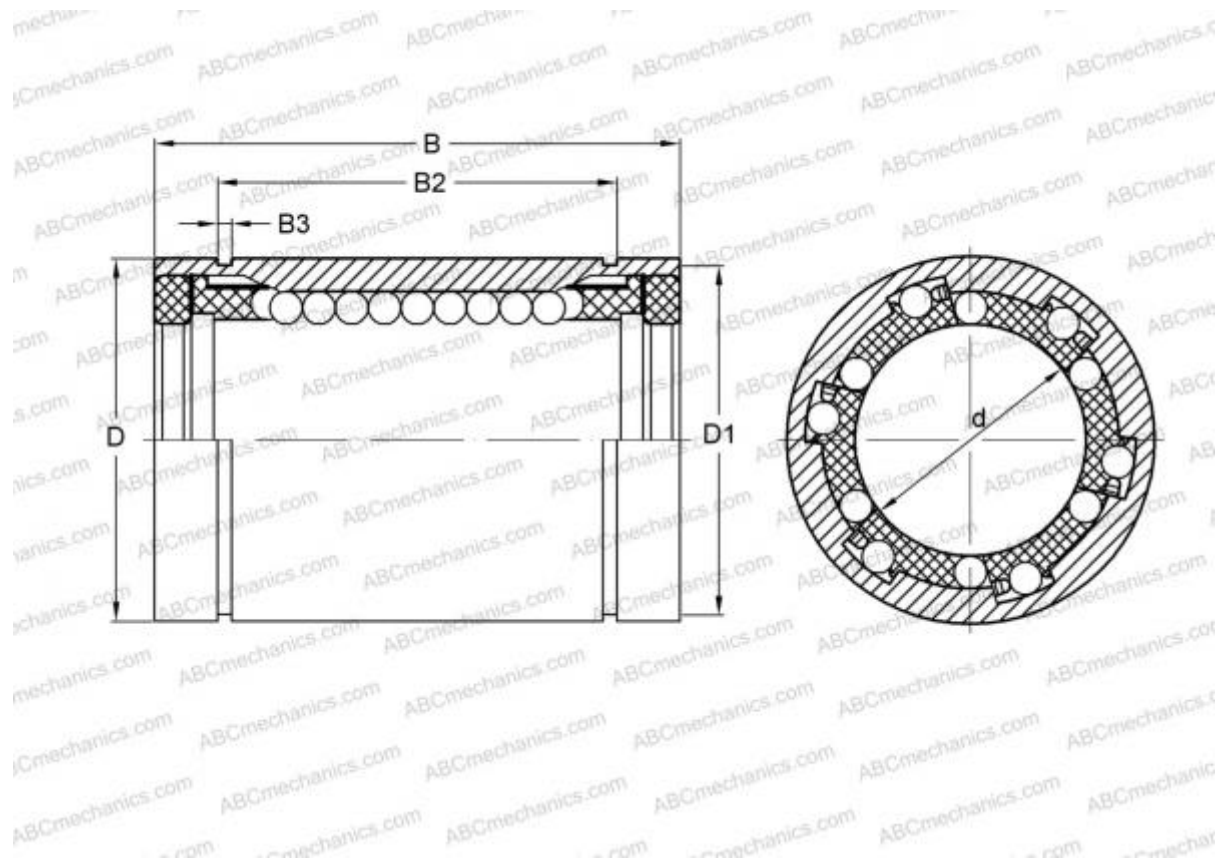

Technical specification

DIMENSIONS, MM

d	20,000
D	32,000
B	45,000

WEIGHT, KG 0,105

MANUFACTURER [IKO](#)

INTERCHANGE

ABC	LME 203245 UU
STAR	0602-020-10
THOMSON	0602-020-10

CALCULATION DATA

Basic dynamic load rating min	0,562 kN
Basic dynamic load rating max	0,668 kN
Basic static load rating min	1,010 kN

CALCULATION DATA

Basic static load rating max	1,470 kN
------------------------------	----------