

LME 254058 UU IKO

Linear bushing

TYPE: Shaft guidance systems, Linear bushing, Standard, Close type, Type LME..(N) UU, sealed on both sides

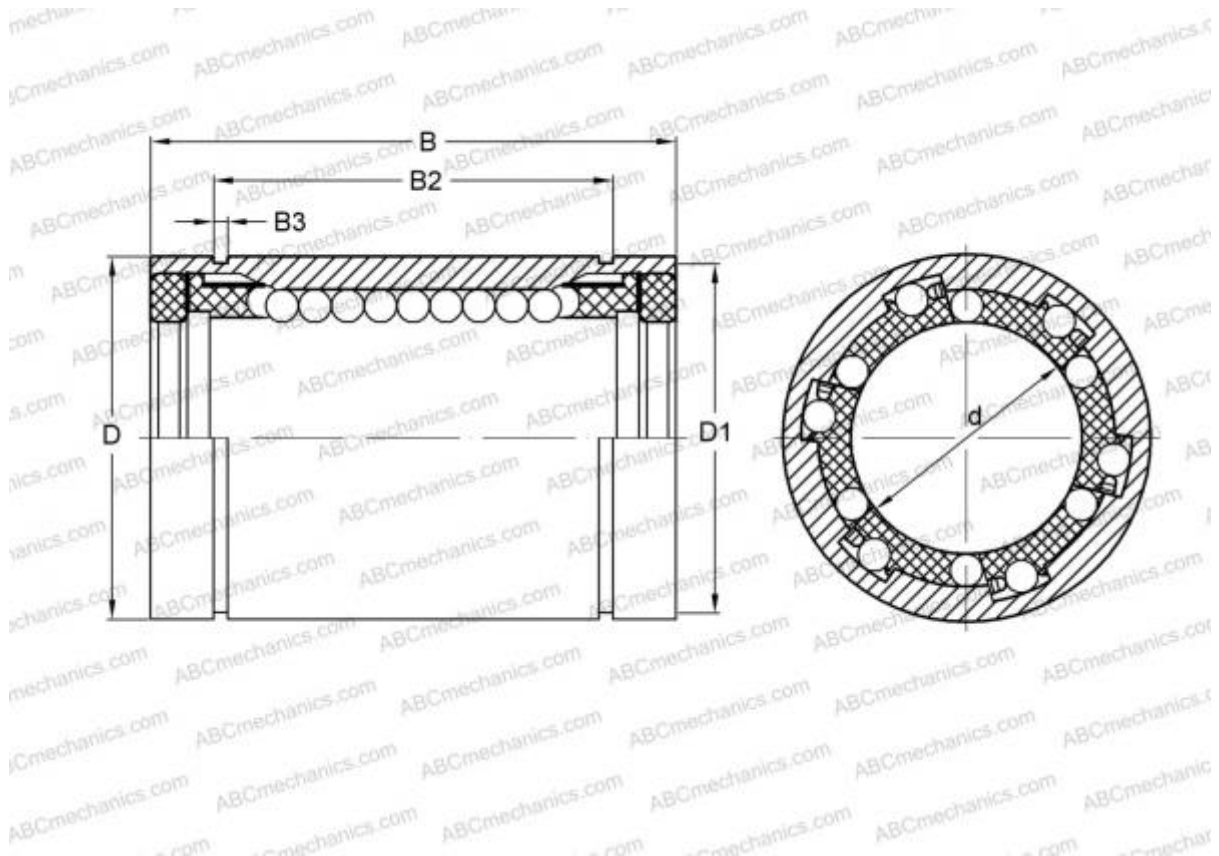

Technical specification

DIMENSIONS, MM

d	25,000
D	40,000
B	58,000

WEIGHT, KG 0,240

MANUFACTURER [IKO](#)

INTERCHANGE

ABC	LME 254058 UU
STAR	0602-025-10
THOMSON	0602-025-10

CALCULATION DATA

Basic dynamic load rating min	0,920 kN
Basic dynamic load rating max	0,974 kN
Basic static load rating min	1,780 kN

CALCULATION DATA

Basic static load rating max	2,280 kN
------------------------------	----------